

MEUBLES DE BAINS BADMÖBEL MOBILI DI BAGNO

2017

framo
SWISS MADE

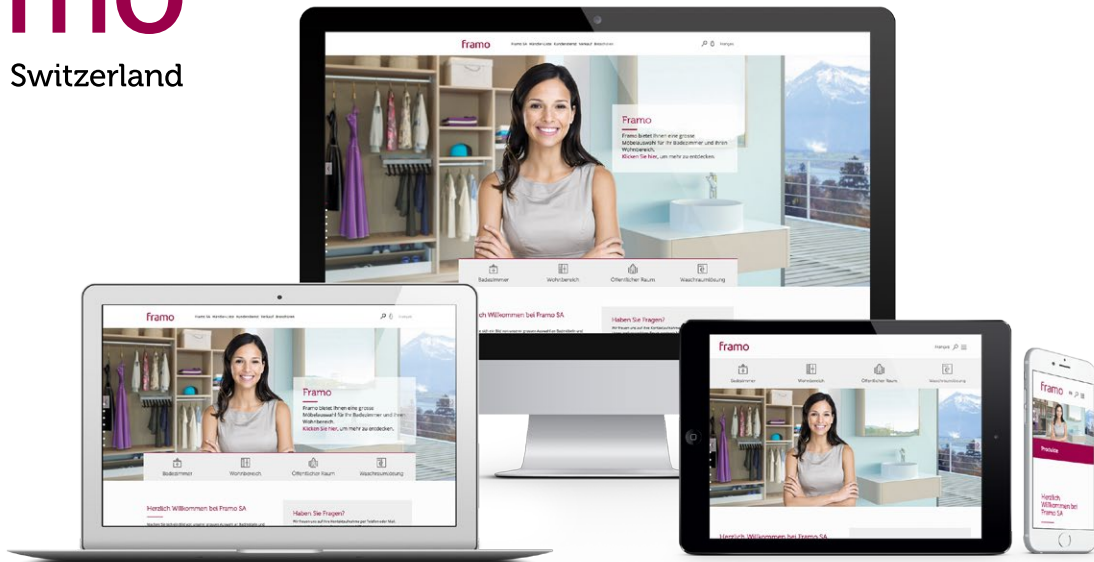



Apprenez à connaître davantage Framo – Visitez notre site internet - il y a tellement à découvrir.
 Lernen Sie Framo etwas näher kennen – schauen Sie sich um auf unserer Website – es gibt viel zu entdecken.
 Venite a conoscere meglio Framo – date un'occhiata al nostro sito web per scoprire la nostra ampia offerta.

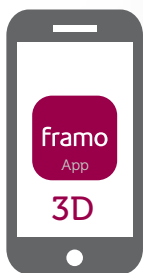

Expérience en 3D

A l'aide de ce logo présent sur chaque page, découvrez et visualisez les produits Framo en 3D. Pour ce faire:

1. Téléchargez gratuitement l'application Framo.
2. Scannez cette page grâce au QR scanner de l'application.
3. Découvrez nos meubles en 3D.

3D erleben

Auf jeder Seite mit diesem Logo können Sie die Framo-Produkte 3D erleben. Und so funktioniert es:

1. Kostenlose Framo-App laden.
2. Diese Seite mit dem QR-Scanner dieser App scannen.
3. Unsere Möbel in 3D erleben.

Vivere il 3D

Su tutte le pagine con questo logo potete scoprire i prodotti Framo in 3D. Ecco come:

1. Caricate l'app Framo gratuita.
2. Scannerizzate questa pagina con lo scanner QR dell'app.
3. Scoprite i nostri mobili in 3D.



04 Meubles de salles de bains | Badmöbel Mobili da bagno

- 06 Artissimo
- 08 Création 2
- 10 Fino
- 12 Glano-Family: Ceram | Mineral | Top
- 22 ProCasa Uno
- 24 ProCasa Uno Slim
- 26 ProCasa Tre
- 28 Vetro



70 Solution buanderie | Waschraumlösung Soluzione lavanderia



74 Service après-vente | Kundendienst Servizio dopo vendita



30 Meubles de salles de bains pour table en céramique à choix Badmöbel mit wählbarem Keramik- waschtisch Mobili da bagno con lavabo in ceramica a scelta

- 32 Basic
- 34 Claro
- 36 Confort
- 42 Slim
- 46 Universel



48 Miroirs / Armoires de toilette Spiegel / Spiegelschränke Specchi / Armadi a specchio

- 50 Bella
- 50 Doppio
- 51 Création 2
- 51 Elite New Generation
- 52 Illumino
- 52 Lena
- 52 Linea
- 53 Mezzo-Bella
- 53 Mezzo-New Generation
- 53 Stand-alone



56 Armoires | Schränke | Armadi

- 58 Flexi
- 59 Spacio



60 Choix | Auswahl | Scelta

- 62 Poignées | Griffe | Maniglie
- 64 Porte-linges | Handtuchhalter |
Porta asciugamano
- 64 Accessoires | Zubehör | Accessori
- 66 Lavabos | Becken | Lavabi
- 68 Couleurs | Farben | Colori

> Répertoire d'images | Bildverzeichnis Catalogo

Une image dans notre brochure vous plaît particulièrement? – de plus amples détails peuvent être trouvés via le code QR dans le répertoire digitale d'images de la brochure.

Ein Foto in der Broschüre gefällt Ihnen ganz besonders – die genauen Angaben dazu finden Sie via unten stehenden QR-Code im digitalen Bildverzeichnis zur Broschüre.

Ha trovato una foto nella brochure che le piace particolarmente? Con il codice QR accederà alla versione digitale del catalogo, dove potrà ottenere informazioni dettagliate.



FR



DE

Dessins techniques: toutes les mesures en mm
Massskizzen: alle Masse in mm
Schizzo quotato: tutte le misure in mm



Meubles de salles de bains

Badmöbel

Mobili da bagno

06 Artissimo

08 Création 2

10 Fino

12 Glano-Family: Ceram | Mineral | Top

22 ProCasa Uno

24 ProCasa Uno Slim

26 ProCasa Tre

28 Vetro



Options | Optionen | Opzioni

Poignée | Handgriff | Maniglia



Avec
Mit
Con



Push open



Liste décor
Griffleiste
Listella decorativa

Meuble | Möbel | Mobili



Portes
Türen
Porte



Tiroirs
Schubladen
Cassetti



Portes et tiroirs
Türen und Schubladen
Porte e cassetti

Lavabos | Becken | Lavabi



Posé
Aufgesetzt
D'appoggio



Semi-encastré
Halbeinbau
Semi-incasso



Encastré par-dessous
Einbaubecken
Lavabo da incasso



> 6-1

artissimo

Une élégance naturelle. Un design épuré et des matériaux de haute qualité pour une atmosphère contemporaine. La table et les côtés du meuble sont en mineral-art, tout comme le lavabo.

Elegante Schönheit. Edles Design gibt Badräumen eine freundliche Atmosphäre. Die Waschtischabdeckung und die Möbelseiten sind wie das Becken aus hochwertigem mineral-art gefertigt.

Eleganza naturale. Design lineare e materiali di alta qualità per un'atmosfera contemporanea. Il piano e i fianchi del mobile sono realizzati in mineral-art, come anche il lavabo.



> 7-1



> 7-2



> 7-3

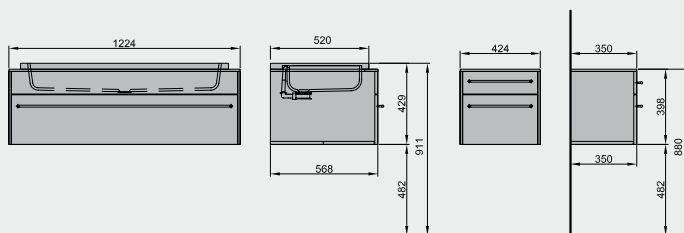
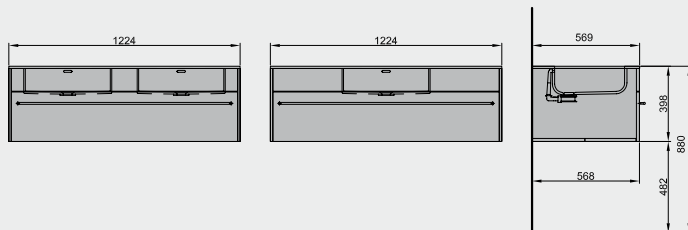

Meubles
Möbel
Mobili



Poignées
Griffe
Maniglie



Lavabos
Becken
Lavabi





> 8-1



> 8-2



> 8-3



> 8-4



> 8-5



> 8-4

8-5

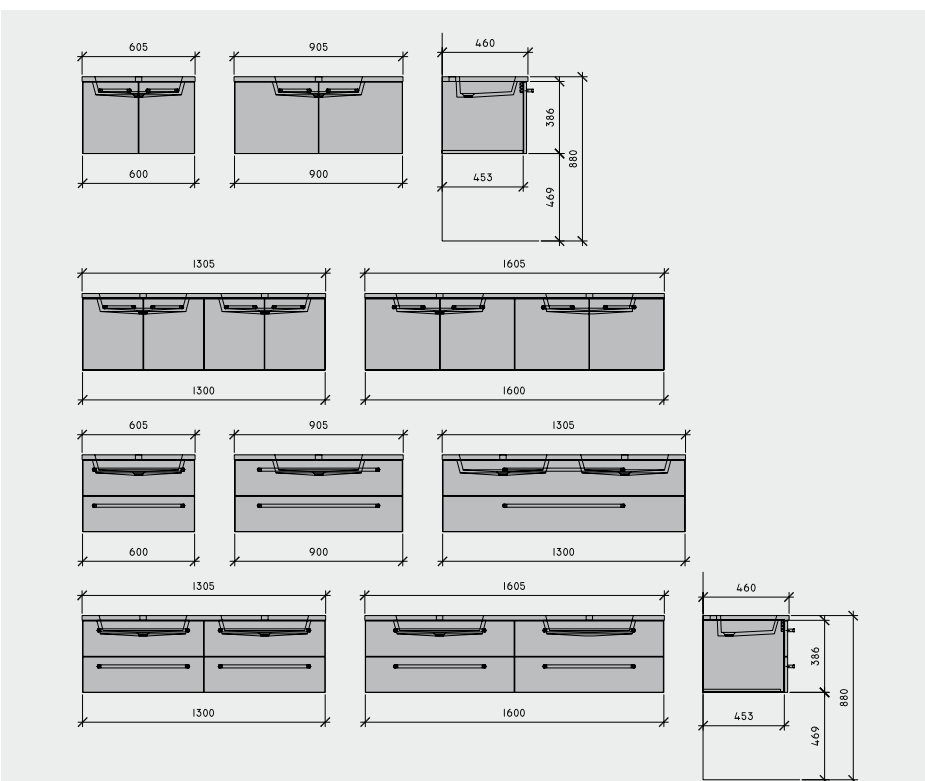

Poignées
Griffe
Maniglie



Meubles
Möbel
Mobili





> 9-1

création 2

Création 2 est synonyme d'une forte dose de design contemporain. Les formes géométriques épurées des vasques parlent d'elles-mêmes. Sans compter la collection de meubles convertibles sans poignées, dont les listes de décor sont disponibles dans tous les coloris Framo, ou avec une poignée à choisir parmi la vaste gamme de Framo.

Création 2 steht für modernes Design im höchsten Masse. Klare geometrische Formen der Becken sprechen für sich. Zum wandelbaren, grifflosen Möbelprogramm sind Griffleisten in allen Framo-Farben oder Griffe aus dem breiten Framo-Griffsortiment erhältlich.

Création 2 è sinonimo di design moderno di grado supremo. Le chiare forme geometriche dei lavabi parlano da sole. In abbinamento, un programma di mobili convertibili senza maniglie, con listelli decorativi disponibili in tutti i colori Framo, oppure con maniglia a scelta nell'ampio assortimento Framo.







> 10-1

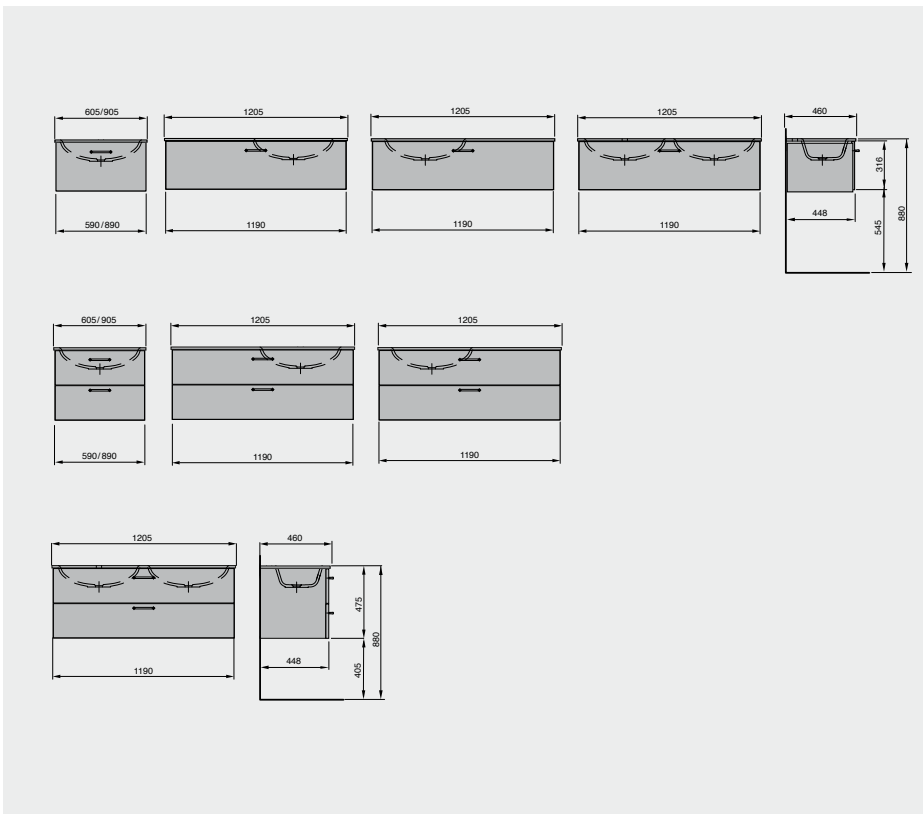

10-2



- Meubles  
- Möbel
- Mobili

- Poignées  
- Griffe
- Maniglie

Autres variantes sur www.framo.ch
 Andere Varianten unter www.framo.ch
 Altre varianti su www.framo.ch



fino

Fino est d'un design moderne et stylé. La table de lavabo fine et arrondie moulée en marbre artificiel se combine parfaitement avec le meuble, et ce dans toutes les couleurs Framo, afin de former un ensemble luxueux et harmonieux.

Fino steht für modernes, geschwungenes Design. Durch die dünne, abgerundete Abdeckung aus Mineralguss und den Möbeln in allen Framo-Farben wirkt das Möbel luxuriös und edel.

Fino è sinonimo di design moderno e sinuoso. Un mobile pregiato e lussuoso grazie alla copertura sottile e arrotondata in mineralguss e disponibile in tutta la gamma di colori Framo.

> 11-1



> 12-1

glano CERAM

Glano Ceram – Une table mince et contemporaine en céramique posée avec un intervalle sur le meuble ce qui apporte un style élégant. Les formes et la fonctionnalité se marient de façon optimale.

Choisissez parmi les différentes déclinaisons de meubles, avec ou sans poignée, ainsi que votre couleur favorite parmi notre large gamme afin de donner votre touche personnelle à votre composition unique.

glano Ceram – eine dünne zeitgemässe Keramikabdeckung leicht abgesetzt durch eine Schattenfuge von den Möbeln. Form und Funktion ideal kombiniert. Wählen Sie aus verschiedenen Möbeleinteilungen, Griffen oder auch Grifflos Ihre Wunschkombination aus und geben mit der richtigen Farbe die ganz persönliche Note.

Glano Ceram, un moderno e sottile top in ceramica separato dai mobili da una fessura quasi invisibile. Combinazione ideale di forma e funzionalità. Selezionate il vostro abbinamento preferito tra diverse categorie di mobili, maniglie o anche soluzioni prive di maniglie e aggiungete un tocco personale con il colore giusto.



> 13-1



> 13-2

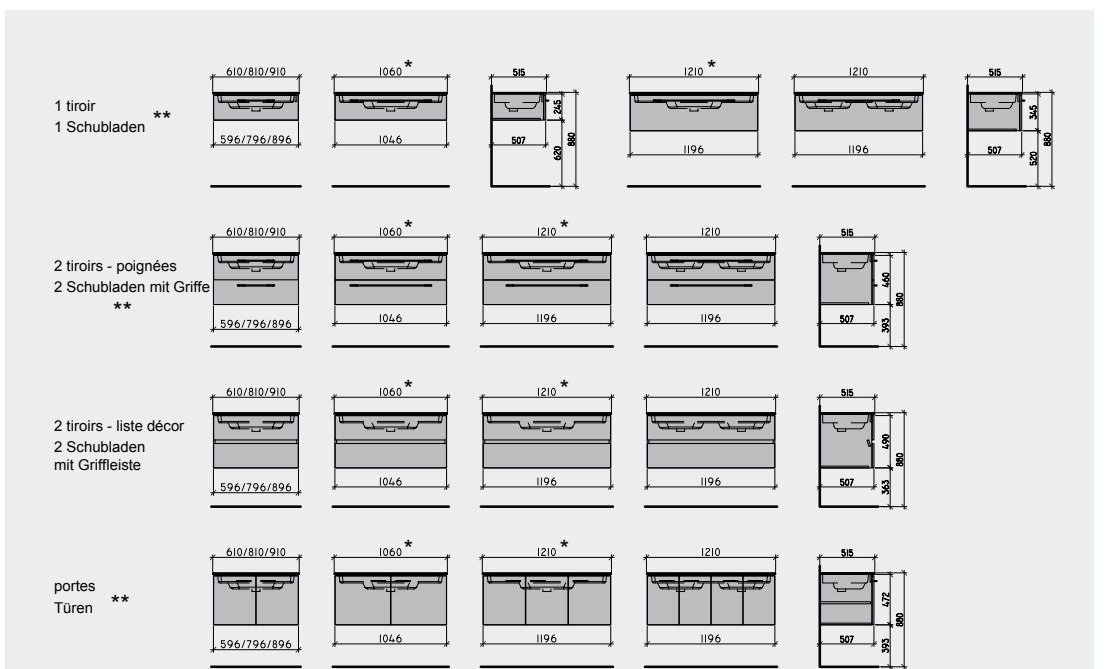

Meubles
Möbel
Mobili



Poignées
Griffe
Maniglie

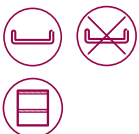

* table avec lavabo gauche-milieu-droite
* Abdeckung mit Lavabo Links-Mitte-Rechts
** avec poignée ou Tip-ON
** mit Griffe oder Tip-ON



> 14-1



> 14-2



> 14-3



> 16-4

Poignées
Griffe
Maniglie



Meuble
Möbel
Mobili



Lavabos
Becken
Lavabi





glano MINERAL

Glano Mineral – Une table mince et stylée avec le lavabo coulé en marbre artificiel posée avec un intervalle sur le meuble pour un style contemporain. Ses formes et sa fonctionnalité s'associent pour offrir un meuble idéal. Choisissez parmi les différentes déclinaisons de meubles, avec ou sans poignée, et choisissez votre couleur favorite parmi notre large gamme afin de donner votre touche personnelle à votre composition unique.

Glano Mineral – eine dünne zeitgemässe Mineralgussabdeckung leicht abgesetzt durch eine Schattenfuge von den Möbeln. Form und Funktion ideal kombiniert. Wählen Sie aus verschiedenen Möbeleinteilungen, Griffen oder auch Grifflos Ihre Wunschkombination aus und geben mit der richtige Farbe die ganz persönliche Note.

Glano Mineral, un moderno e sottile top a fusione separato dai mobili da una fessura quasi invisibile. Combinazione ideale di forma e funzionalità. Selezionate il vostro abbinamento preferito tra diverse categorie di mobili, maniglie o anche soluzioni prive di maniglie e aggiungete un tocco personale con il colore giusto.

Choix sans limites Auswahl ohne Grenzen Scelta senza limite



Eclairage | Beleuchtung | Illuminazione

66



Miroirs | Spiegel | Specchi

64



Lavabos | Becken | Lavabi

66



Porte-linges
Handtuchhalter
Porta asciugamano

64



Poignées | Griffe | Maniglie

62

Grâce à nos fabrications personnalisées,
nous rendons chaque dimension
réalisable.

Dank unseren individuellen Spezial-
anfertigungen machen wir jedes Mass möglich.

Grazie ai nostri modelli su misura ora
potete averlo ogni dimensione.





Accessoires | Zubehör | Accessori
50

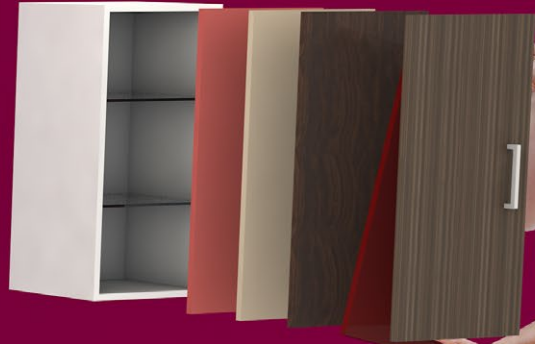

Armoires | Schränke | Armadi
56



Couleurs | Farben | Colori
60



> 18-1

glano TOP

Glano Top – Les merveilleuses déclinaisons Glano Top. Tables de hauteurs et de largeurs différentes. Vous ne trouvez pas la grandeur désirée ? Pas de problème, avec Glano Top, les mesures spéciales sont facilement réalisables. Jouez avec notre large sélection de matériaux pour les tables et ajoutez-y le lavabo à poser de votre choix. Les différentes compositions du programme Glano Top permettent d'associer un grand nombre de matériaux, de poignées ou même sans poignées, et d'une palette de couleurs variée et moderne. Offrez-vous Glano-Top, il répondra à l'ensemble de vos souhaits.

Das Kombinationswunder glano Top. Wählen Sie aus verschiedensten Ausführungen in Breite und Höhe aus. Finden Sie Ihre Wunschmasse nicht – kein Problem auch eigene Spezialmasse sind bei glano Top einfach machbar. Spielen Sie mit der reichen Auswahl an Materialien für die Abdeckungen und wählen Ihre Wunsch-Aufsatzbecken aus. Sie können Ihre Abdeckung auch in zwei verschiedenen Höhen auswählen. Natürlich haben Sie auch bei den Möbeln die grosse Auswahl aus vielen Einteilungsvarianten, Farben, Griffen oder auch Grifflos. Stellen Sie glano Top also ganz nach Ihren Wünschen zusammen.

Glano Top, la combinazione perfetta. Scegliete tra la più vasta gamma di proposte (in termini di larghezza e altezza). E se non trovate l'articolo delle dimensioni che fanno al caso vostro, nessun problema! Con glano Top sono facilmente realizzabili anche soluzioni con misure personalizzate. Giocate e sbizzarritevi con l'ampia scelta di materiali disponibili per realizzare i top e scegliete il piano lavabo che più desiderate. Potrete inoltre scegliere il top in due diverse altezze. Naturalmente, anche per i mobili avete ampia scelta tra molteplici varianti di combinazioni, colori, maniglie o anche soluzioni prive di maniglie. Potrete comporre glano Top in base ai vostri desideri.



> 19-1



19-2

Poignées
Griffe
Maniglie



Meubles
Möbel
Mobili



Lavabos
Becken
Lavabi

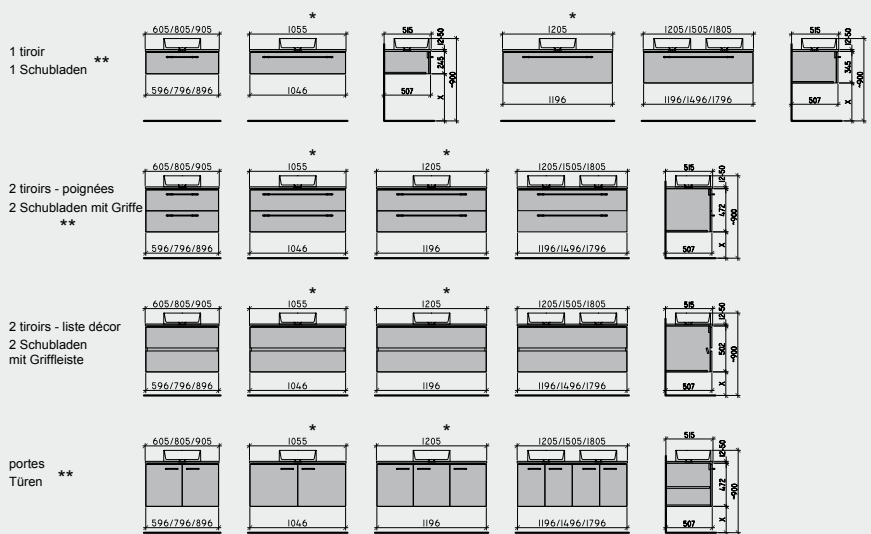

* table avec lavabo gauche-milieu-droite
* Abdeckung mit Lavabo Links-Mitte-Rechts
** avec poignée ou Tip-ON
** mit Griffe oder Tip-ON



> 20-1



> 20-2



> 20-3



> 20-4



> 20-5







> 22 <

ProCasa Uno

Meubles
Möbel
Mobili



Poignées
Griffe
Maniglie



Sa table en céramique avec lavabo rectangulaire séduira par son style élégant et raffiné. ProCasa Uno est proposé avec portes ou tiroirs selon sa dimension. La parfaite fusion de la table et du meuble, alliée à une large gamme de couleurs, confère à ce meuble un équilibre parfait.

Die Keramikabdeckung verführt durch die klare Form der rechteckigen Becken. ProCasa Uno ist in verschiedenen Größen und Ausführungen mit Türen und Schubladen erhältlich. Möbel und Keramikabdeckung bilden eine perfekte Einheit. Mit den vielen Farbmöglichkeiten des Möbels, können viele Wünsche erfüllt werden.

La copertura in ceramica seduce grazie alle linee pulite del lavabo rettangolare. ProCasa Uno è disponibile in diverse dimensioni e in diversi modelli con sportelli e cassetti. Mobili e copertura in ceramica costituiscono un'unità perfetta. Grazie alla vasta gamma di colori del mobile, e dalle colonne adeguati, è possibile esaudire molti desideri.

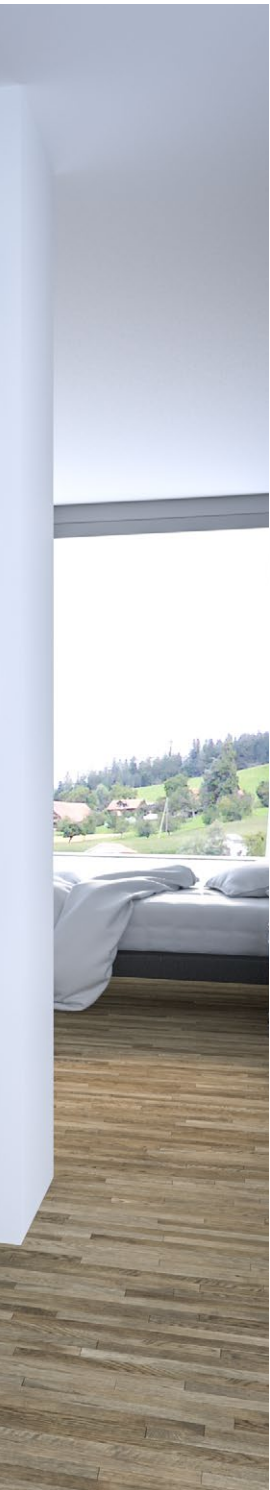

> 23-1



> 23-2

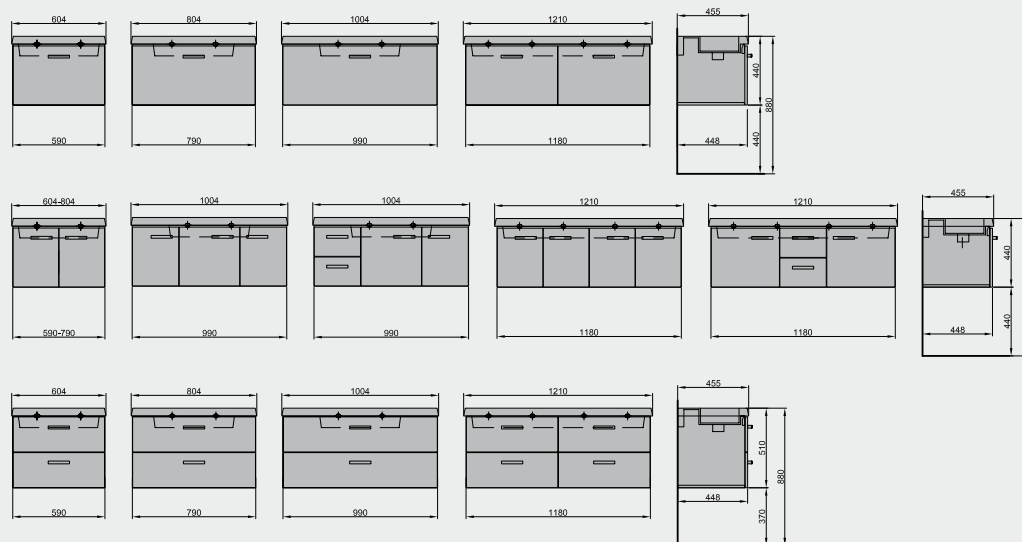



> 24-1



> 24-2

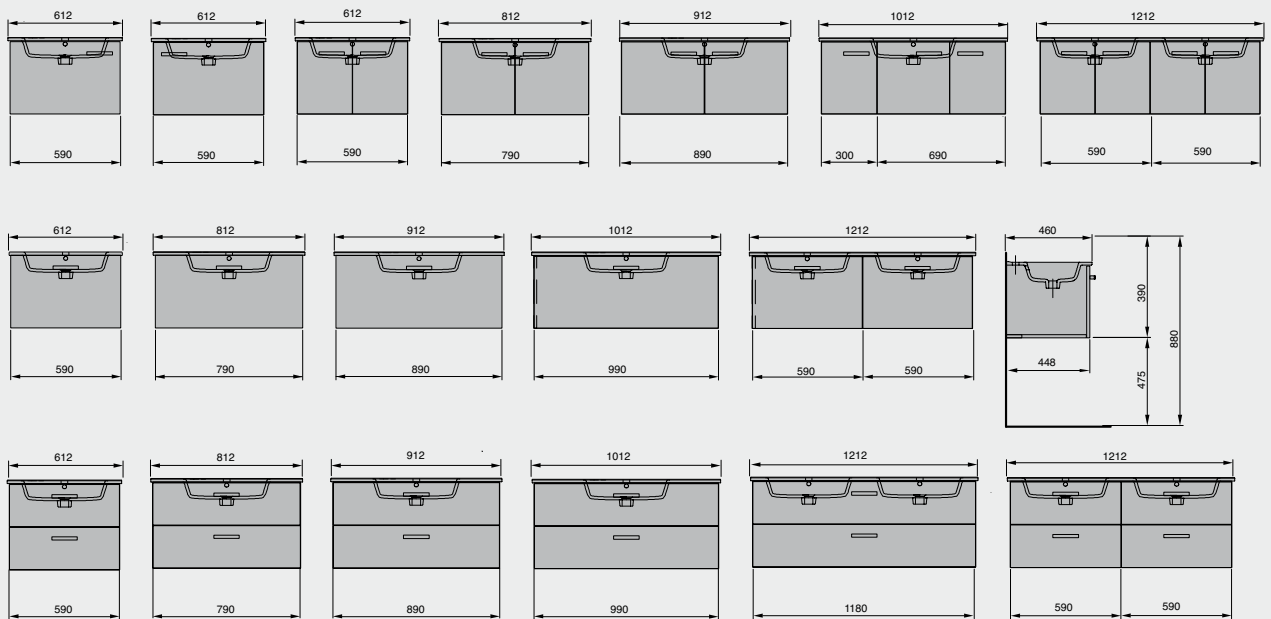



> 25 - 1

ProCasa Uno Slim

Avec sa table fine en céramique au design épuré et élégant, ProCasa Uno Slim confère un air contemporain à toutes salles de bains tout en offrant une place de rangement optimale.

Mit seiner feinen und dezerten Keramikabdeckung bringt ProCasa Uno Slim einen Hauch von Modernität ins Badzimmer und bietet dazu auch noch viel Stauraum.

Poignées
Griffe
Maniglie



Meubles
Möbel
Mobili



Con la raffinata e sobria copertura in ceramica, ProCasa Uno Slim porta in bagno un tocco di modernità e offre al tempo stesso molto spazio.



> 26-1

ProCasa Tre

Une table en céramique fine, élégante et raffinée, combinée avec notre gamme de meubles et listes décors ; disponibles dans toutes les couleurs et différents modèles Framo.

Eine dünne, elegante Keramikabdeckung kombiniert mit einem puristischen Möbelprogramm mit Griffleiste erhältlich in allen Framo-Farben und in verschiedenen Ausführungen.

Un rivestimento in elegante ceramica fine combinato a una serie di mobili minimalista con maniglie a filo, disponibile in tutti i colori Framo e in varie finiture.



27-1

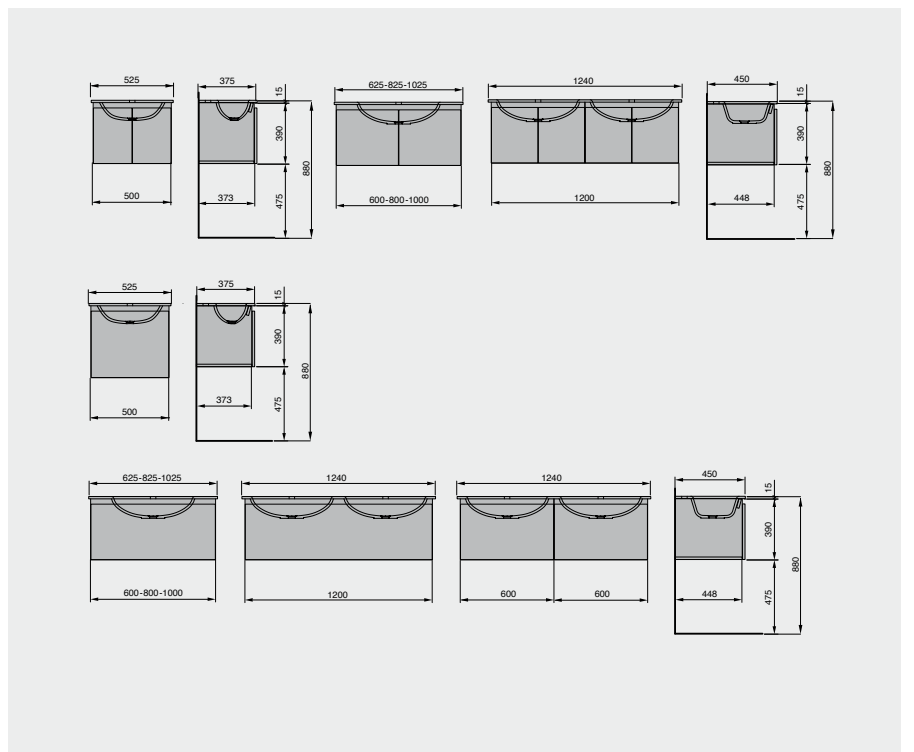

Poignées
Griffe
Maniglie



Meubles
Möbel
Mobili





> 28-1



> 28-2



blanc/weiss/bianco

> 28-3



anthracite/anthrazit/antracite

> 28-4



blanc opaque/weiss opak/bianco opaco

> 28-5

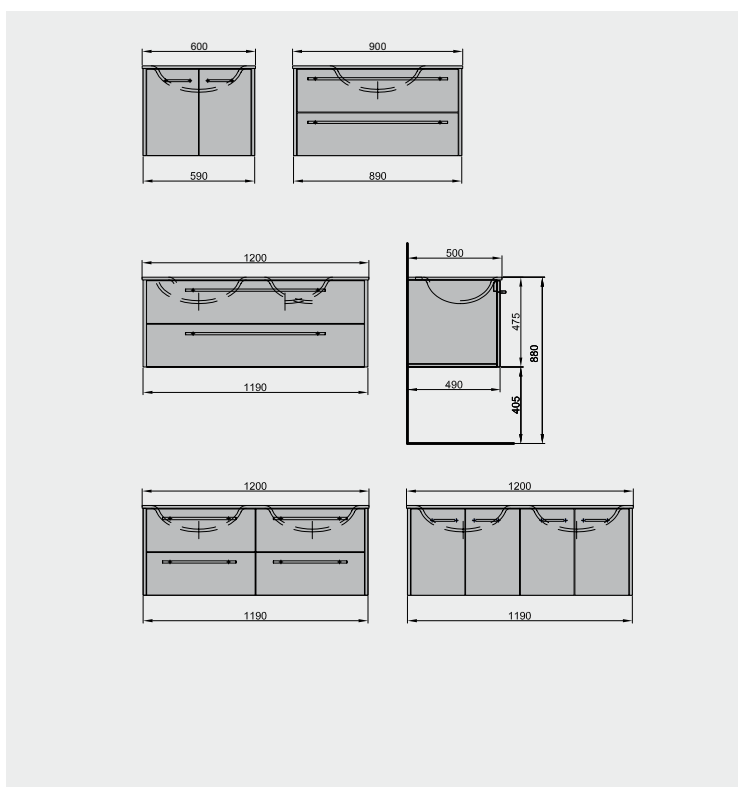

Poignées
Griffe
Maniglie



Meubles
Möbel
Mobili





> 29-1

vetro

Table très chic en verre blanc ou anthracite avec lavabo moulé. A conjuguer avec nos nombreuses couleurs et exécutions pour une création unique, et ce pour un prix attractif. Ça c'est Vetro.

Edle Glasabdeckung mit Glasbecken aus einem Stück und einem variablen Möbelprogramm in verschiedenen Ausführungen und Farben, und dies zu einem attraktiven Preis – das ist Vetro.

Una raffinata copertura in vetro con lavabo monoblocco in vetro e un programma di mobili variabile in diversi modelli e colori, il tutto a un prezzo interessante – questo è Vetro.



Meubles de salles de bains pour table en céramique à choix Badmöbel mit verschiedenen Keramikwaschtisch Mobili da bagno con lavabo in ceramica a scelta

Votre table céramique souhaitée n'est pas répertoriée?
N'hésitez pas à nous contacter.
Autres variantes sur www.framo.ch/fr/category/sub/unterbaumoebel/

Ist Ihr Wunschkeramikwaschtisch nicht dabei? Nehmen Sie mit uns Kontakt auf,
wir finden für Sie eine passende Lösung.
Andere Varianten unter www.framo.ch/category/sub/unterbaumoebel/

Non trovate il vostro lavabo preferito? Non esitate a contattarci.
Altre varianti su www.framo.ch/fr/category/sub/unterbaumoebel/

32 Basic

34 Claro

36 Confort

42 Slim

46 Universel





Options | Optionen | Opzion

Poignée | Handgriff | Maniglie



Avec
Mit
Con



Push open



Liste décor
Griffleiste
Listella decorativa

Meubles | Möbel | Mobili



Portes
Türen
Porte



Tiroirs
Schubladen
Cassetti



Portes et tiroirs
Türen und Schubladen
Porte e cassetti

Tables en céramique
Abdeckungen jeweils aus Keramik
Rivestimenti in ceramica



> 32-1

basic

Poignées
Griffe
Maniglie



Meubles
Möbel
Mobili



Meuble traditionnel offrant beaucoup de rangement. Faites votre choix parmi la large gamme de tables en céramique et nous vous construirons le meuble adéquat. La série Basic d'un style intemporel répondra à toutes vos attentes. Disponible pour les tables en céramique suivantes >

Klassische Möbel mit viel Stauraum. Wählen Sie aus einer Vielzahl verschiedener Keramikabdeckungen und wir bauen Ihr Möbel dazu. Die Serie Basic verspricht optimalen Stauraum und zeitlose Wirkung im Bad. Erhältlich zu folgenden Keramikabdeckungen >

Mobili classici con tanto spazio da sfruttare. Scegliete tra una vastissima gamma di coperture in ceramica e noi costruiremo il vostro mobile. La serie Basic garantisce spazio da sfruttare in modo ottimale, conferendo al vostro bagno un'eleganza senza tempo. Disponibili per le seguenti coperture in ceramica >



> 33-1



basic | Gallery

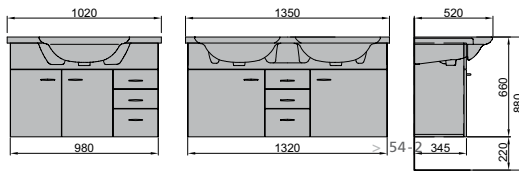

Votre table céramique souhaitée n'est pas répertoriée.
N'hésitez pas à nous contacter.
Autres variantes sur www.framo.ch/fr/category/sub/unterbaumobel/

Ist Ihr Wunschkeramikwaschtisch nicht dabei? Nehmen Sie mit uns
Kontakt auf, wir finden für Sie eine passende Lösung.
Andere Varianten unter www.framo.ch/category/sub/unterbaumobel/

Non trovate il vostro lavabo preferito? Non esitate a contattarci.
Altre varianti su www.framo.ch/fr/category/sub/unterbaumobel/



basic | Moderna

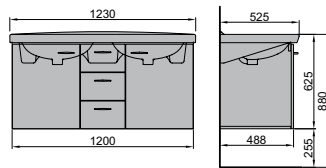

basic | Fiora

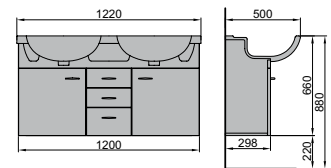

basic | ModernaPlus

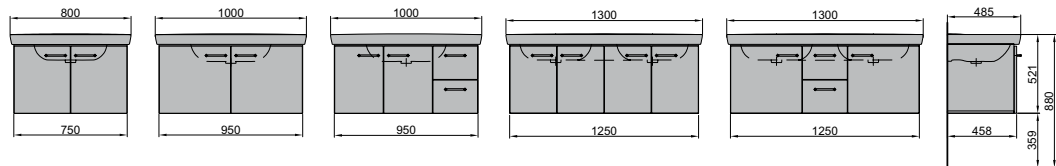

basic | Talux New

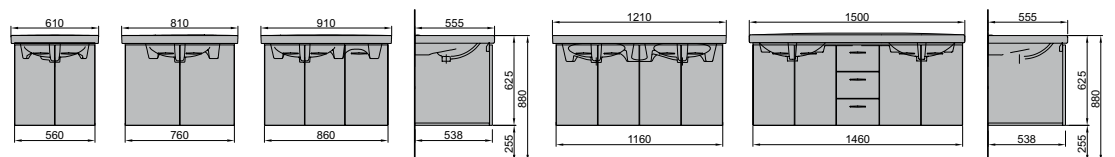



> 34-1

claro

Beau et pratique. Meubles compatibles avec un grand choix de tables en céramique. L'espace entre le meuble et la table lui apporte une allure aérienne. Faites votre choix parmi des couleurs mates. Disponible pour les tables en céramique suivantes >

Schön praktisch. Möbel zu einer grossen Auswahl an Keramikabdeckungen. Der freie Raum zwischen Keramik und Möbel garantiert einen leichten Auftritt. Wählen Sie aus vielen matten Farben. Erhältlich zu folgenden Keramikabdeckungen >

Belli e pratici. Mobili per una vasta gamma di coperture in ceramica. Lo spazio libero tra ceramica e mobile assicura leggerezza. Scegliete tra numerosi colori opachi. Disponibili per le seguenti coperture in ceramica >



> 35-1



> 35-2



claro | Gallery

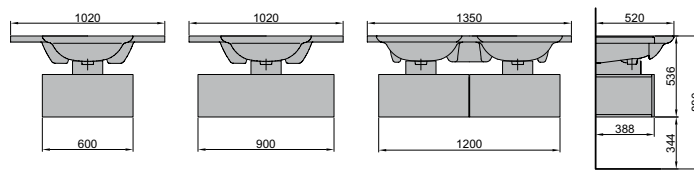

claro | Moderna

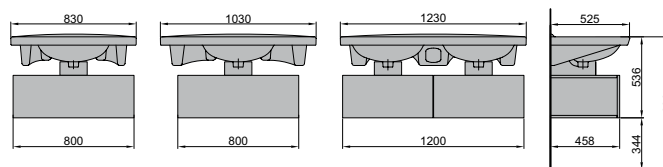

Meubles
Möbel
Mobili



claro | Palomba

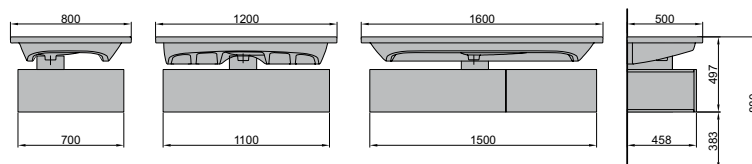



> 36-1



> 36-2

confort

D'une sobriété et d'une élégance intemporelle. De vastes tiroirs vous raviront par leurs côtés fonctionnels et esthétiques. Choisissez entre différentes tables en céramique, pour un ensemble unique. Disponible pour les tables en céramique suivantes >

Schlicht und elegant. Confortmaler Stauraum dank geräumigen Schubladen. Wählen Sie aus verschiedenen Keramikabdeckungen Ihren Favoriten aus. Erhältlich zu folgenden Keramikabdeckungen >

Sobrio ed elegante. Il massimo spazio da sfruttare grazie agli ampi cassetti. Scegliete tra le diverse coperture in ceramica quella che preferite. Disponibili per le seguenti coperture in ceramica >



confort | Connect

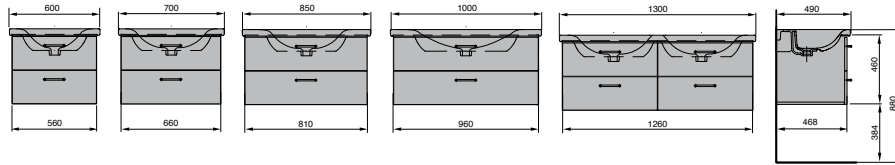

confort | 2nd Floor

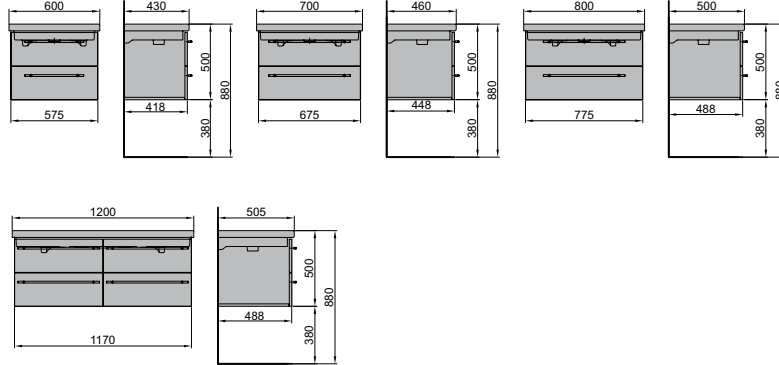

confort | Icon

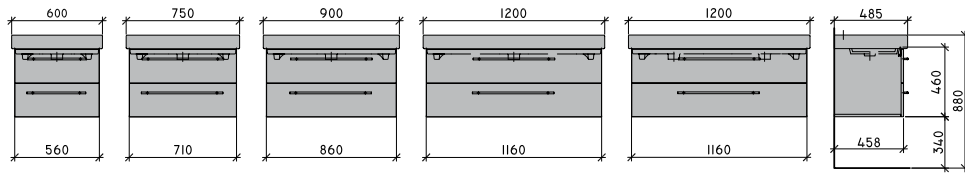

confort | Living City

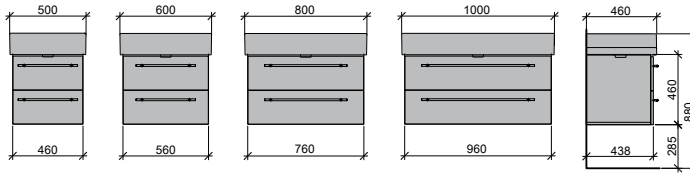

confort | Living Square

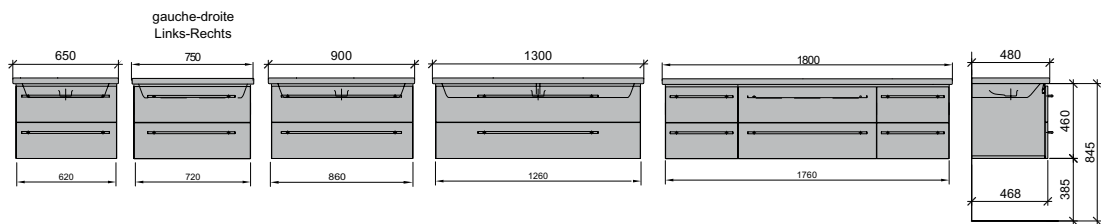

confort | Me by Starck

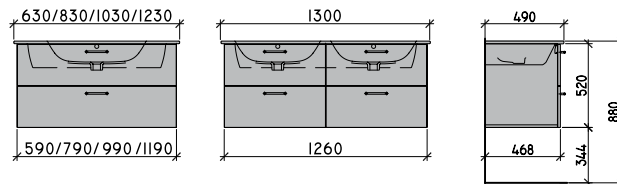



confort | Memento

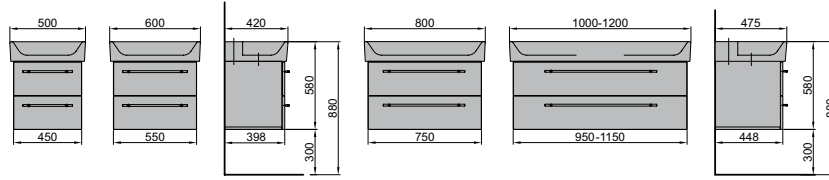

confort | Moderna

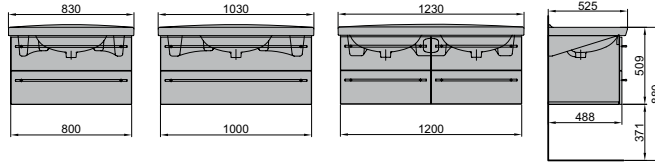

confort | ModernaPlus

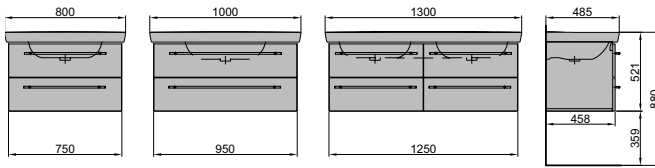

confort | Palace

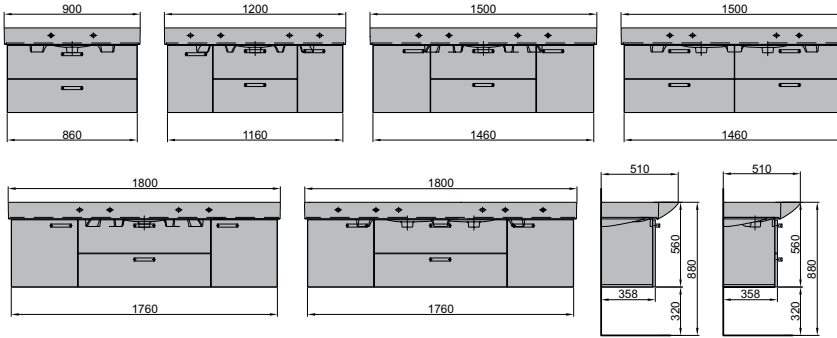

confort | Palace NEW

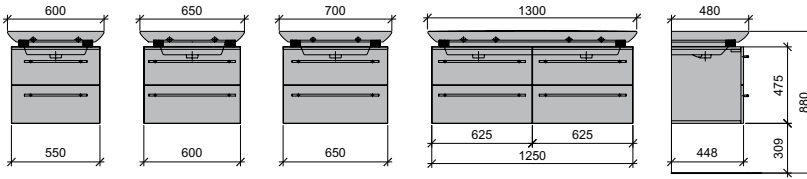

confort | Palomba

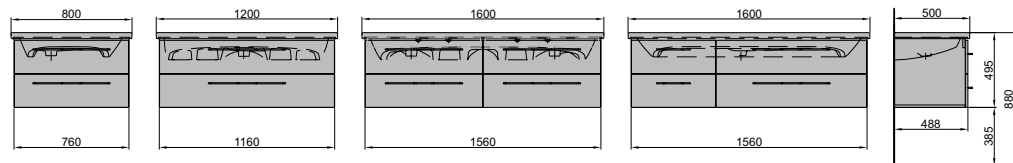



confort | Palomba NEW

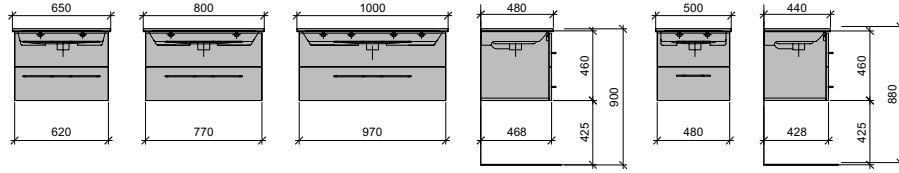

confort | Preciosa 2

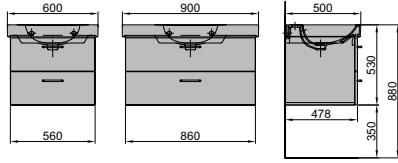

confort | Pro

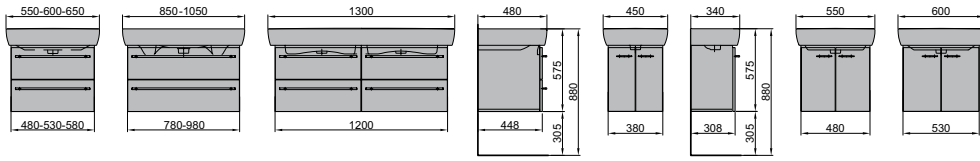

confort | Pro S

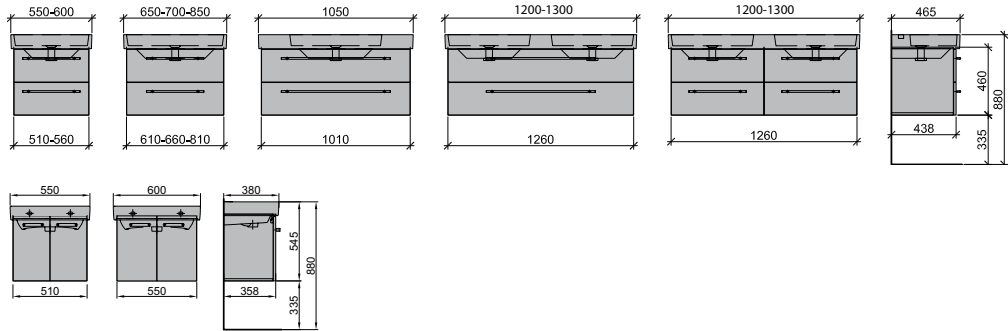

confort | Sentique

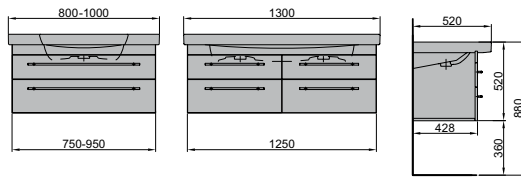

confort | Starck 3

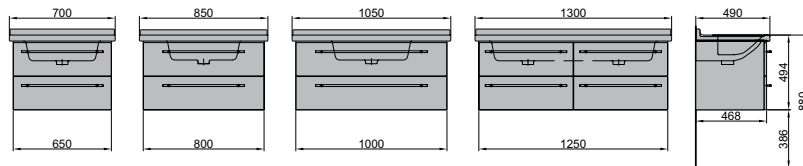



confort | Strada

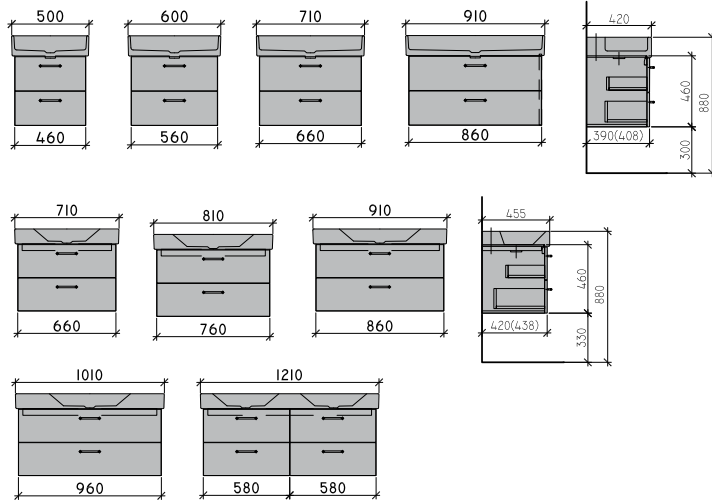

confort | Subway 2

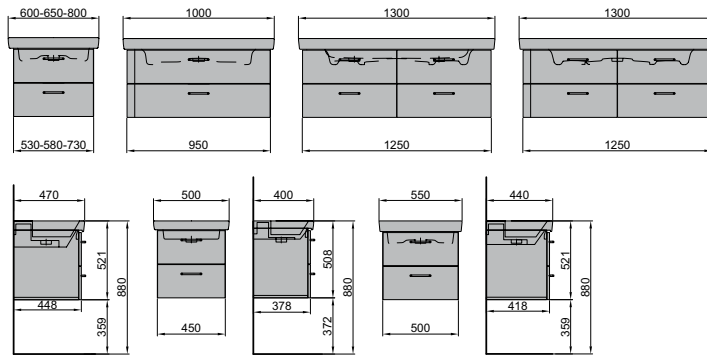

confort | Talux New

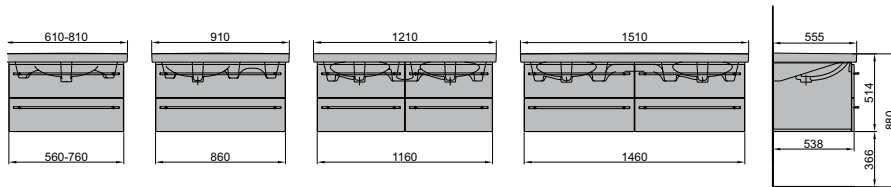

confort | Venticello

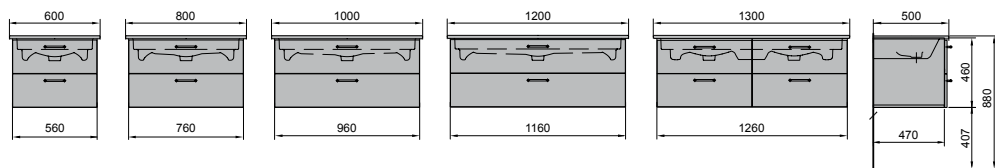

confort | Vero

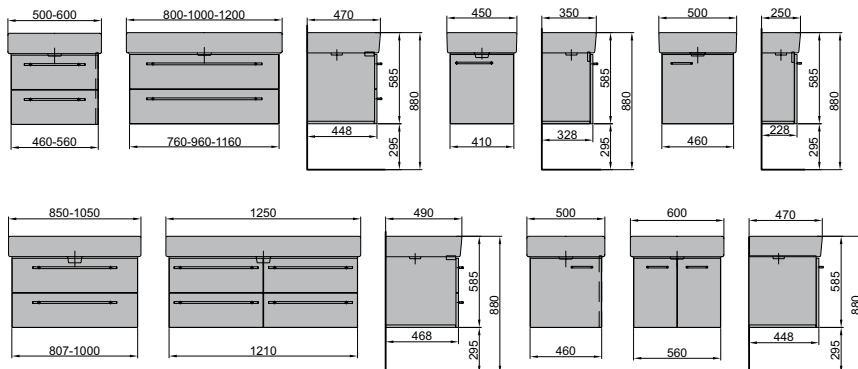

Framo-App

Plongez dans l'univers de Framo grâce à notre application et profitez de nombreuses idées d'aménagement pour votre salle de bains.

Tauchen Sie mit unserer App in die Framo-Welt ein und genießen Sie die vielfältigen Badeinrichtungsideen.

Immergetevi nel mondo di Framo con la nostra app e scoprite le innumerevoli idee per l'arredamento del bagno.





> 42-1

slim

Slim, un programme varié et moderne pour tables en céramique très actuelles. Il se distingue grâce à sa ligne sobre et élégante et ses poignées typiques Slim. Il peut aussi être équipé de toutes les poignées de l'assortiment Framo. Un design pur avec de nombreuses possibilités de couleurs, et ce pour un prix attractif – ça c'est Slim. Programme compatible avec les tables céramique suivantes >

Slim, ein Programm passend zu verschiedenen modernen und aktuellen Keramikwaschtischen. Überzeugt durch seine elegante und klare Linie. Original mit den typischen Slim-Griffen, bestehend jedoch auch mit den anderen Griffen aus dem Framo-Griffsortiment. Schönes Design mit vielen Farbmöglichkeiten zu einem attraktiven Preis – das ist Slim. Erhältlich zu folgenden Keramikabdeckungen >

Slim, un programma adatto a diversi lavabi in ceramica moderni e attuali. Convince grazie alla sua linea elegante, con maniglie dall'aspetto piacevole e di grande impatto che si integrano perfettamente nell'immagine complessiva. Design raffinato e una vastissima gamma di colori a un prezzo interessante – questo è Slim. Disponibile per le seguenti coperture in ceramica >

Meubles
Möbel
Mobili



Poignées
Griffe
Maniglie



> 43-1



slim | Connect

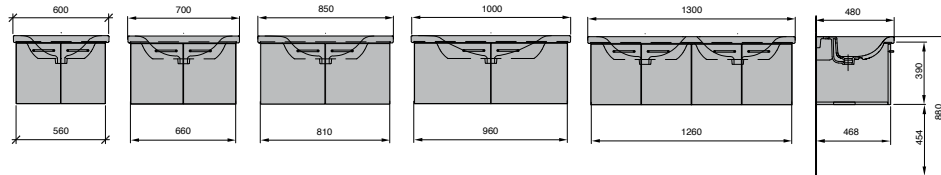

slim | Icon

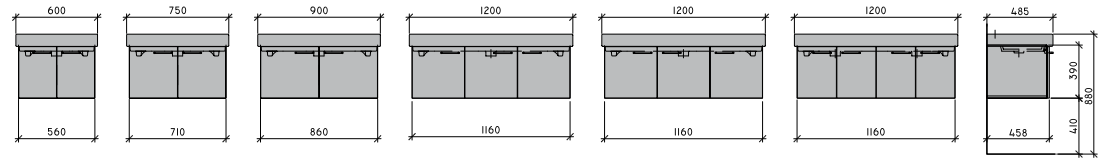

slim | Living City

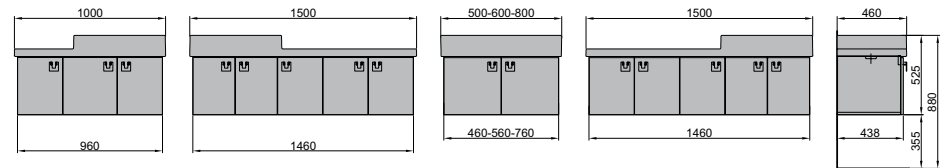

slim | Living Square

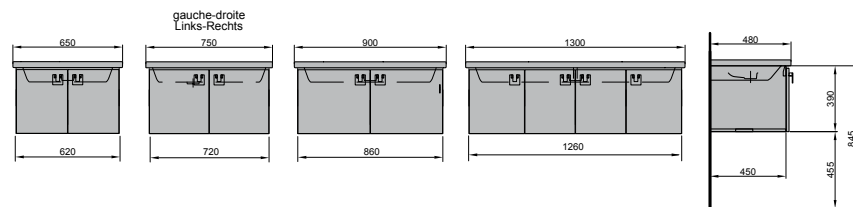

slim | Memento

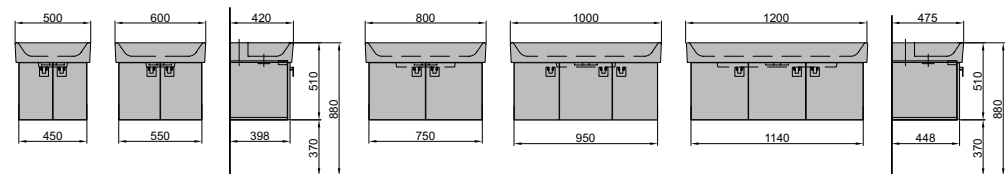

slim | ModernaPlus

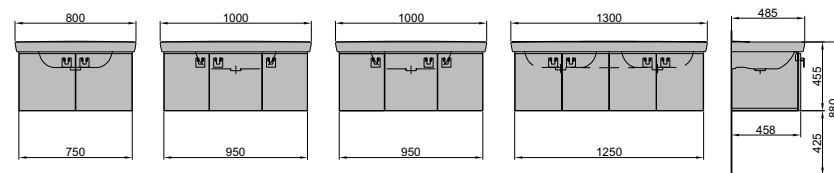

slim | Me by Stark

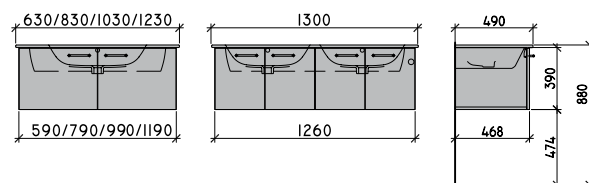



slim | Palace

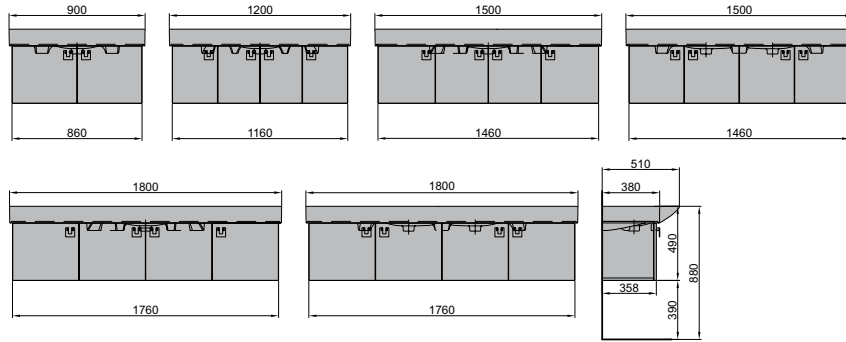

slim | Palace NEW

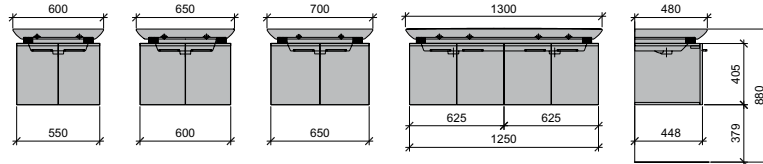

slim | Palomba

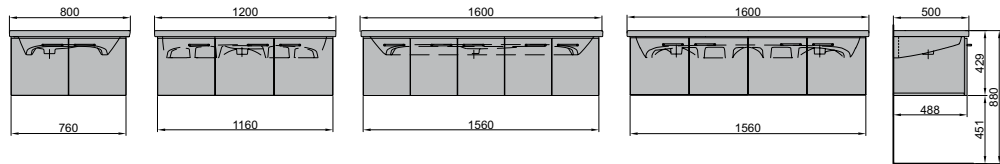

slim | Palomba NEW

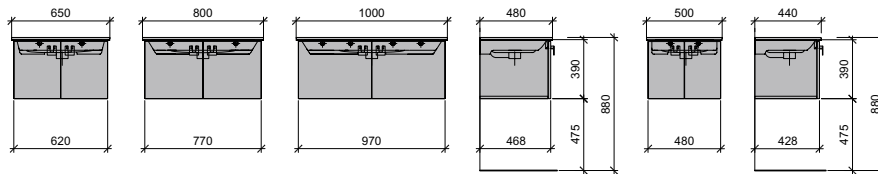

slim | Preciosa 2

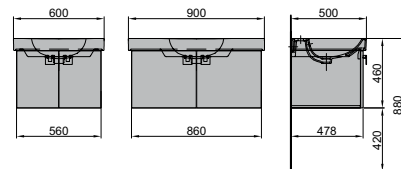

slim | Pro

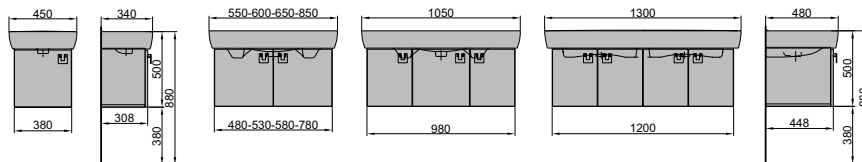

slim | Pro S

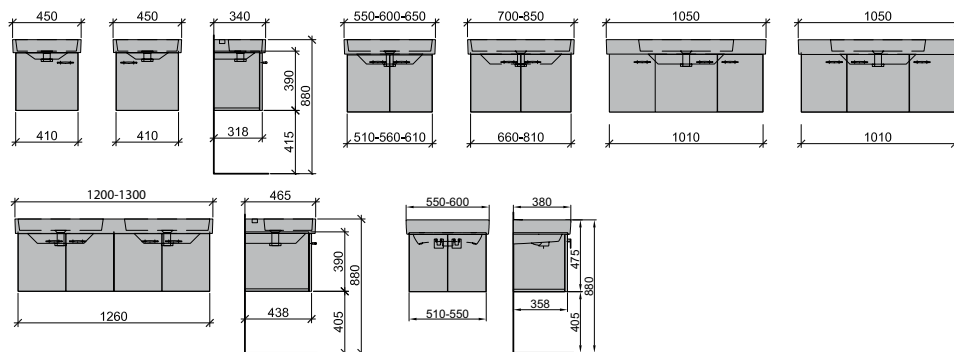



slim | Starck 3

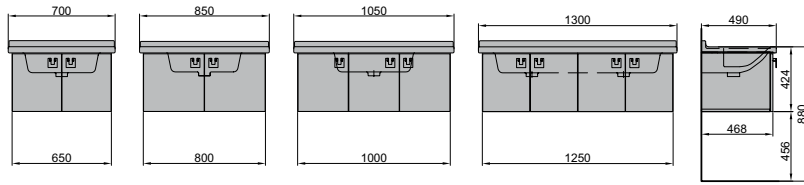

slim | Strada

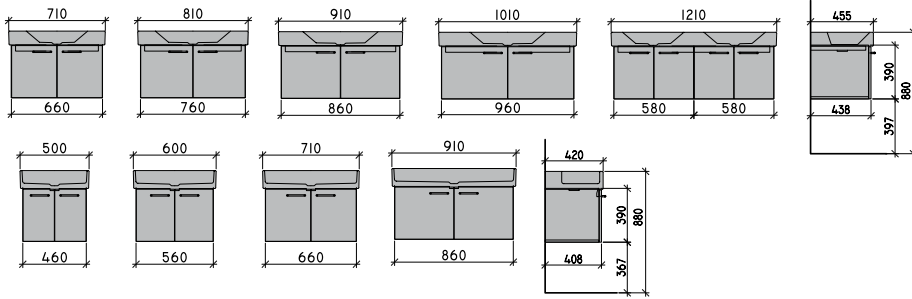

slim | Subway 2

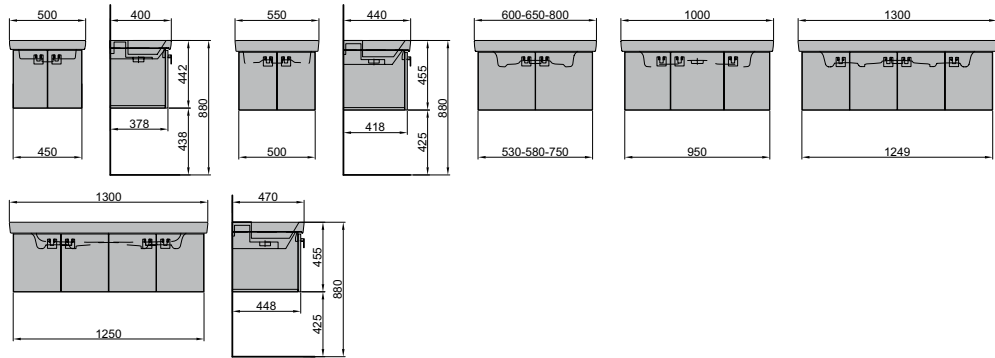

Slim | Venticello

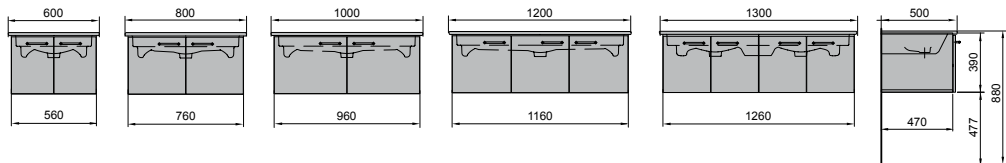

slim | Vero

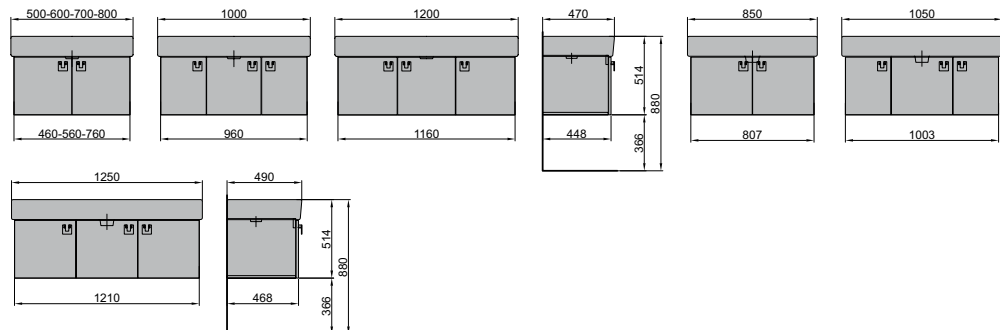



> 46-1

universel

Le complément idéal pour la pose murale convenant à toutes les tables en céramique.

Die ideale Möbelergänzung für die Wandmontage, passend zu jedem Keramikwaschtisch.

Il complemento ideale per mobili con montaggio a parete, perfetto per tutti i lavabi in ceramica.



> 47-1

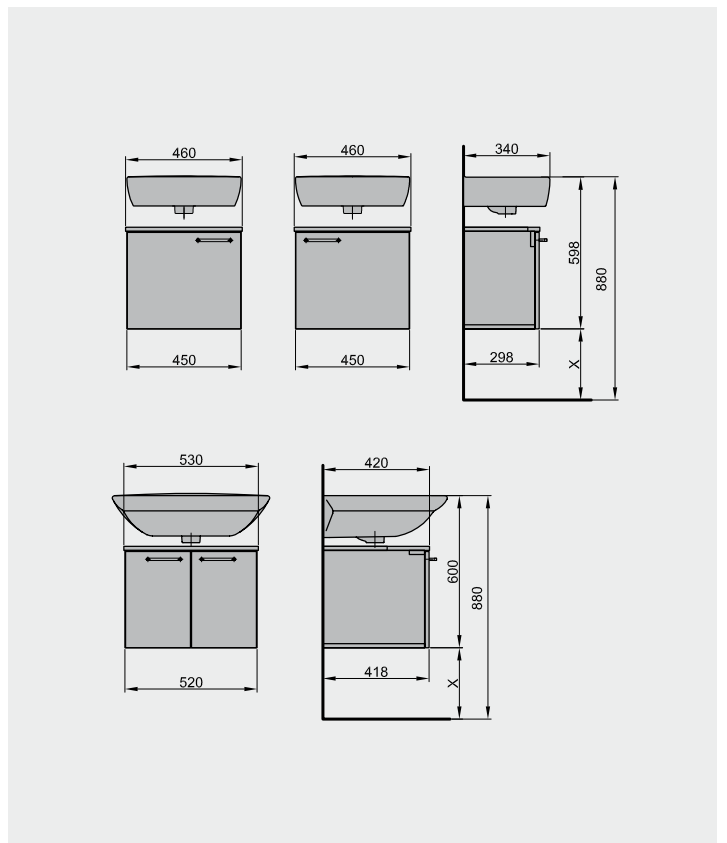

Meubles
Möbel
Mobili



Poignées
Griffe
Maniglie





Miroirs / Armoires de toilette Spiegel / Spiegelschränke Specchi / Armadi a specchio



50	Bella
50	Doppio
51	Création 2
51	Elite New Generation
52	Illumino
52	Lena
52	Linea
53	Mezzo-Bella
53	Mezzo-New Generation
53	Stand-alone



made for
me

Type de miroir | Spiegelart | Tipo di specchio



Panneau miroir
Spiegelwand
Parete a specchio



Armoire de toilette
Spiegelschrank
Armadio a specchio



Armoire de toilette à encastrer
Einbauspiegelschrank
Armadio a specchio da incasso

Type de lumière | Lichtart | Tipo di luce



Fluorescent
Fluoreszenz
Fluorescente



Diode électroluminescente
Leuchtdiodenz
Diodo luminoso

Options | Optionen | Opzioni



Variateur
Dimmer
Dimmer



Variateur de couleur
Licht-Temperatur-Schalter
Regolatore per la temperatura della luce



Prise électrique
Steckdose
Presa



Rayon
Tablar
Ripiano

Informations | Informationen | Informazioni



Profondeur Panneau miroir variable
Ex. Panneau miroir Bella: 71 mm sans prise électrique / 95 mm avec prise électrique.

Variable Spiegelwand-Tiefe
Bsp. Spiegelwand Bella:
71 mm ohne Steckdose / 95 mm mit Steckdose

Profondità specchio variabile
Es. Parete a specchio Bella:
71 mm sin presa / 95 mm con presa.



Eclairage indirect LED

Nos armoires de toilettes (voir symbole) peuvent être complétées avec un éclairage indirect LED(choix de l'emplacement de la lumière possible, soit en haut ou en bas, voire les deux).

Indirekte LED-Beleuchtung

Unsere Spiegelschränke (siehe Symbol) können zusätzlich mit indirekten LED-Beleuchtungen unter und auf dem Schrank ausgestattet werden.

Illuminazione LED indiretta

I nostri armadi a specchio (vedi simbolo) sono dotati anche di un'illuminazione LED indiretta in basso e sull'armadio stesso.



60/80/90/100/120/130/140/
150/160 cm

60/80/90/100/120/130/140/
150/160 cm

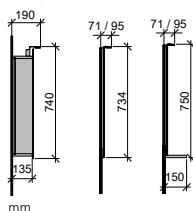

Bella

Lignes simples et pures – un éclairage LED impressionnant de par son élégance et sa sobriété.

Schlichte klare Form – eine LED-Beleuchtung welche durch Eleganz und Nüchternheit überzeugt.

Forme lineari e chiare: un'illuminazione LED che convince per la sua eleganza e la sua naturalezza.

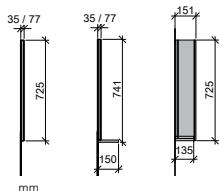
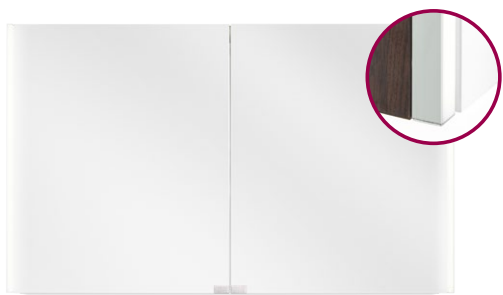

50/60/80/90/100/120 cm

60/90/120 cm

Doppio

Deux lumières LED élégantes, ultramodernes entourent l'armoire de toilette avec finesse.

Zwei feine elegante und topmoderne LED-Beleuchtungen umrahmen den praktischen Spiegelschrank.

Due eleganti e modernissime luci LED avvolgono questo pratico armadio a specchio.

Création 2

Le panneau miroir LED et l'armoire de toilette répondra aux passionnés de mode qui affectionnent particulièrement des lignes claires et sobres.

> voir aussi à la page 9

Elegante, schlichte LED-Spiegelwand und Spiegelschrank für modebewusste Menschen, die klare, schlichte Linien bevorzugen.

> siehe auch auf Seite 9

Parete a specchio con LED elegante e sobria per chi segue la moda e predilige linee semplici e chiare.

> vedi anche pagina 9

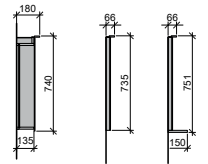

40/45/60/90/100/120/130/150/160 cm

60/80/90/100/120/130/140/150/160 cm

Elite-New-Generation

Des miroirs de grandes surfaces et de beaux volumes de rangement pour un confort optimal – combiné à un éclairage moderne LED de haute technologie.

Grosse Spiegelflächen und viel Stauraum bieten grossen Komfort – kombiniert mit topmoderner LED-Technologie.

Grandi superfici a specchio e molto spazio contenitivo offrono un grande comfort – insieme alla modernissima tecnologia LED.

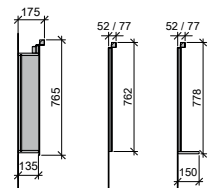

60/90/120/150 cm

60/80/90/100/120/130/140/150 cm

Illumino

Illumino est un panneau miroir très élégant qui accroche le regard par ses deux LED.

Illumino ist eine sehr elegante Spiegelwand, die durch die zwei LED-Leuchten ein optischer Blickfang bildet.

Illumino con le sue due lampade LED è uno specchio molto elegante.



Lena

Armoire de toilette charmante avec un éclairage agréable et beaucoup d'espace.

> voir aussi à la page 11

Der charmante Spiegelschrank mit angenehmem Licht und viel Stauraum.

> siehe auch auf Seite 11

La seduzione di un armadio a specchio con una luce piacevole e tanto spazio da sfruttare.

> veda anche alla pagina 11

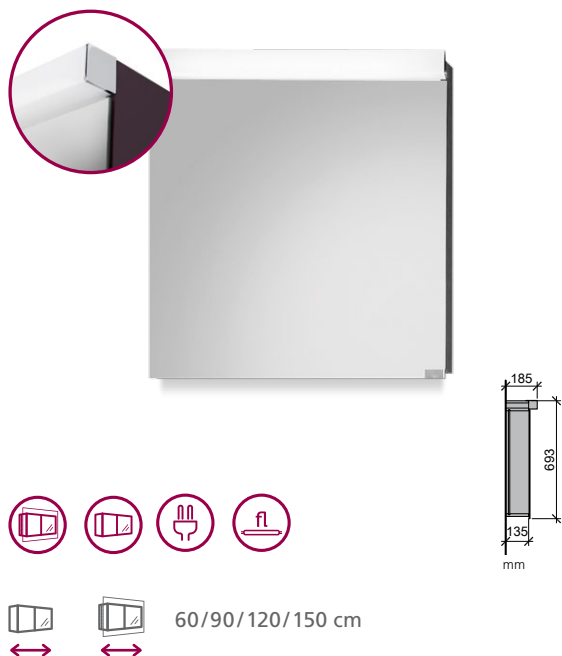

Linea

Réduit à l'essentiel – lignes fines et élégantes – éclairage LED performant.

Reduziert auf das Wesentliche – klare feine Linien – gutes LED-Licht.

Solo l'essenziale: linee chiare e pulite con una buona luce LED.

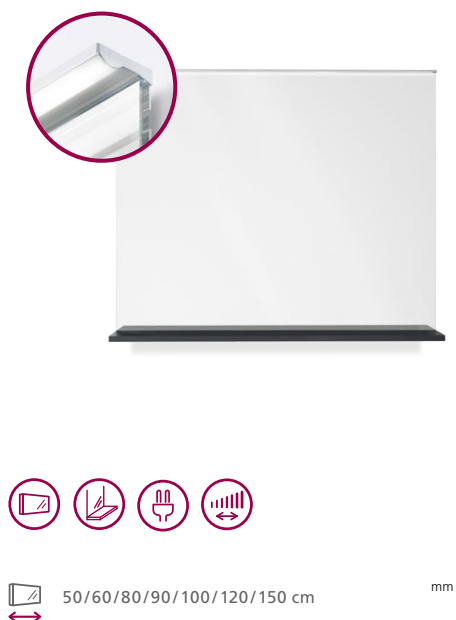

Mezzo - Bella

Une armoire de toilette avec l'éclairage Bella encastré ; mais qui garde les avantages d'un panneau miroir.
Son espace de rangement demeure optimisé mais se caractérise par l'élégance et la discrétion d'un panneau miroir.

Ein einbaufähiger Spiegelschrank mit der Bella Leuchte ist das Beste aus beiden Welten – viel Stauraum und flexibel aber doch elegant und diskret wie eine Spiegelwand

Un armadio a specchio componibile della serie Bella con un doppio vantaggio: tanto spazio e flessibilità e al tempo stesso uno specchio da parete elegante e discreto.



63.2/83.2/93.2/103.2/123.2/133/143/153/163 cm

Mezzo - New - Generation

Une armoire de toilette avec l'éclairage Viva encastré mais qui présente les avantages d'un panneau miroir. Son espace de rangement demeure optimisé mais se caractérise par l'élégance et la discrétion d'un panneau miroir.

Ein einbaufähiger Spiegelschrank der Viva-Leuchte mit den Vorteilen aus beiden Welten – viel Stauraum und flexibel, aber doch elegant und diskret wie eine Spiegelwand.

Un armadio a specchio componibile della serie Viva con un doppio vantaggio: tanto spazio e flessibilità e al tempo stesso uno specchio da parete elegante e discreto.

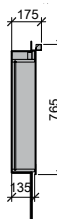
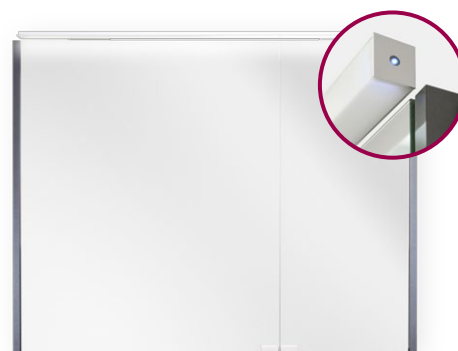

63.2/83.2/93.2/103.2/123.2/133/143/153/163 cm

Stand-alone

L'éclairage Stand-alone se combine à merveille avec un simple panneau miroir.

Die Stand-alone-Leuchte in einer anschluss- und montagefertigen Variante – ideal mit einem einfachen Spiegel kombinierbar.

Le luci Stand-alone in una variante pronta al montaggio e all'installazione: ideali da combinare con uno specchio dalle linee semplici.



mm

↔ 50 cm



> 54-1



> 54-2



> 54-3



> 54-4

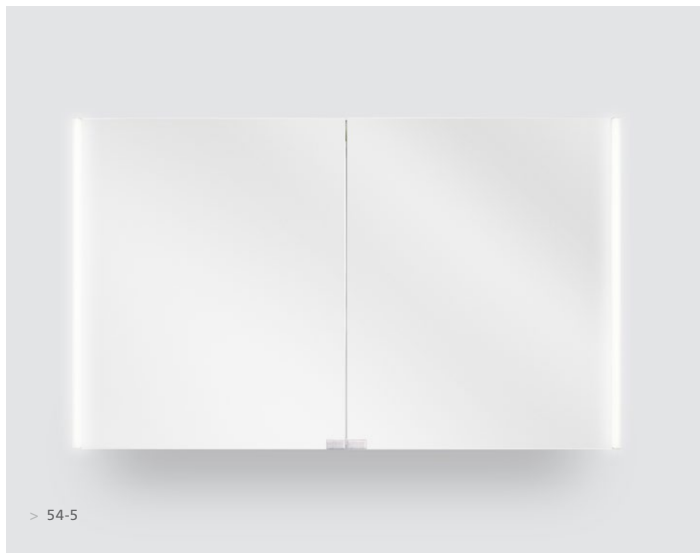

> 54-5





Armoires
Schränke
Armadi

58 Flexi

59 Spacio







> 58-1



> 58-2

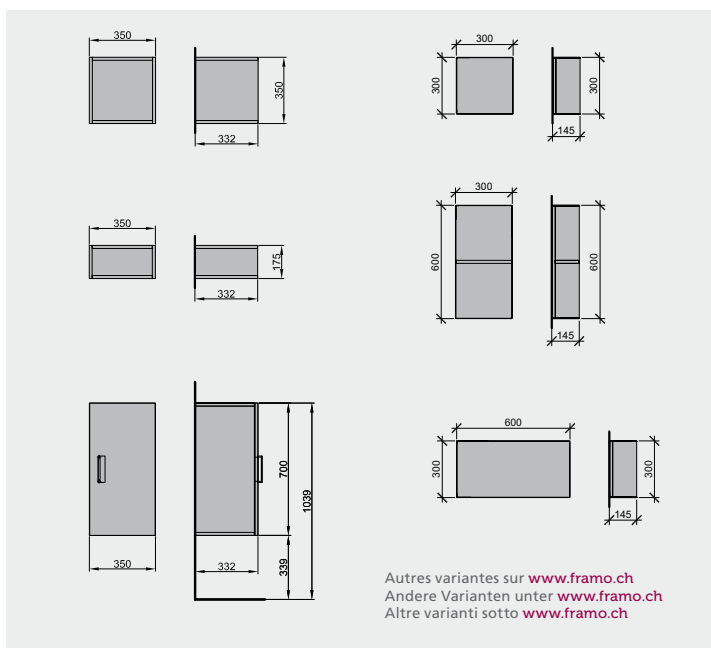

flexi

Amusez-vous à habiller vos murs selon votre espace et votre imagination. Ce programme est une solution astucieuse pour personnaliser sans limite votre salle de bains. Modulo pour un résultat unique.

Möblieren Sie Ihre Wände nach Ihren Vorstellungen. Modulo bietet kluge, gefällige und moderne Möglichkeiten, um Ihr Bad ohne Grenzen nach Ihren Vorstellungen zu gestalten. Modulo ermöglicht einzigartige Resultate.

Arredate le vostre pareti secondo la vostra immaginazione. Modulo offre possibilità intelligenti, gradevoli e moderne per realizzare il vostro bagno senza porre limiti alle vostre idee. Modulo consente risultati straordinari.



> 59-1

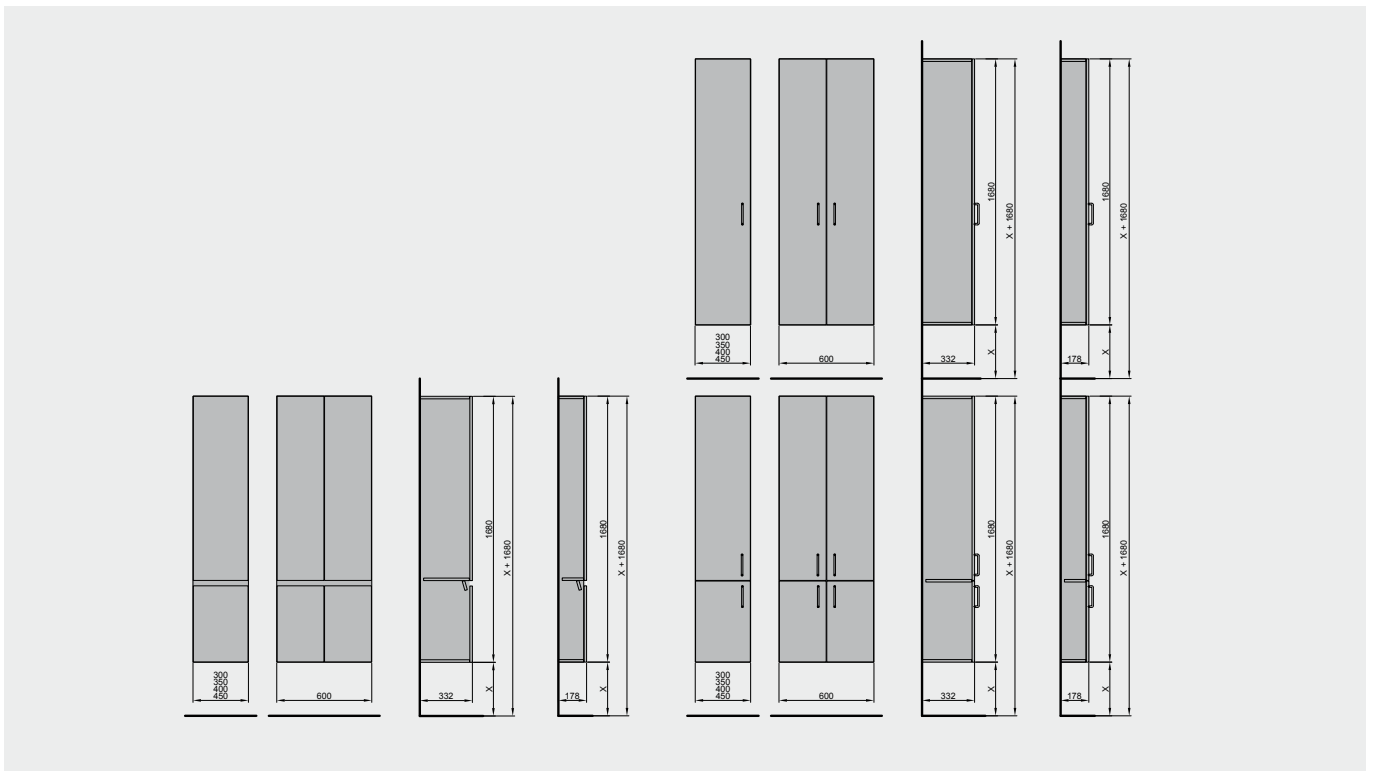

spacio

Grâce à notre assortiment d'armoires hautes, latérales, supérieures et «Cube», vous pouvez jouer à habiller vos murs de rangements modernes et pratiques. Tous nos coloris et poignées sont disponibles pour la totalité de ces armoires, afin de créer un ensemble tout en harmonie. Chaque armoire est équipée avec d'éléments rayons en verre.

Mit unserem Schranksortiment, bestehend aus Hoch-, Seiten- und Oberschränken sowie modernen «Cube»-Möbeln, ist genügend Stauraum vorhanden. Alle unsere Schränke sind selbstverständlich in den passenden Farben zu den Badmöbeln erhältlich und auch das Griffsortiment ist für die Badmöbel und die Schränke identisch. Im Innern sind alle Schränke mit edlen Glastablen ausgestattet.

Grazie al nostro assortimento di armadietti, composto da colonne, basi e pensili nonché dai moderni mobili «Cube», c'è abbastanza spazio da sfruttare. Naturalmente tutti i nostri armadietti sono disponibili nel colore ideale per i mobili per bagno. Anche l'assortimento di maniglie è identico sia per i mobili per bagno sia per gli armadietti. All'interno, tutti gli armadietti sono dotati di raffinati ripiani in vetro.



Choix Auswahl Scelta

62 Poignées | Griffe | Maniglie

64 Porte-linges | Handtuchhalter | Porta
asciugamano

64 Accessoires | Zubehör | Accessori

66 Lavabos | Becken | Lavabi



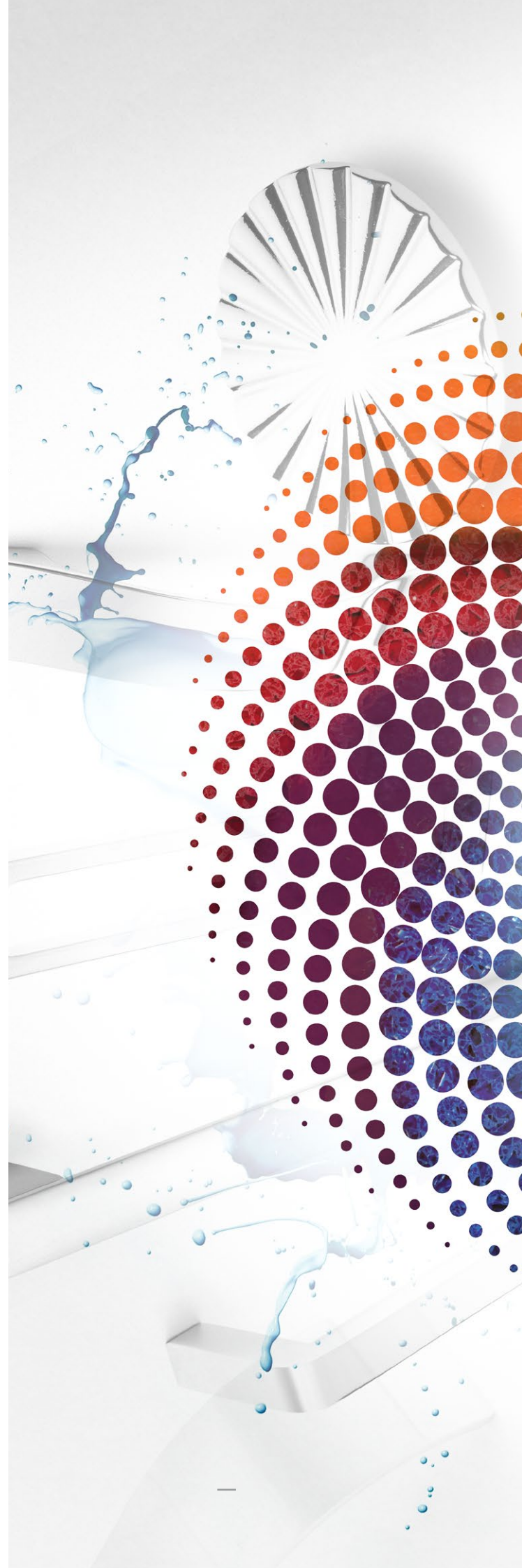













8 68 Couleurs | Farben | Colori







Choix | Auswahl | Scelta

Poignées | Griffe | Maniglie

 Capri, chromé/verchromt/cromato G-Ø 32 mm, l-144 mm	 Capri, chromé/verchromt/cromato G-Ø 128 mm, l-140 mm	 Chic, chromé/verchromt/cromato G-Ø 160 mm, l-184 mm	 Cubic, chromé/verchromt/cromato G-Ø 32 mm, l-50 mm	 Doria, chromé/verchromt/cromato G-Ø 32 mm, l-50 mm
 Léon, chromé/verchromt/cromato l-30 mm	 Frida, chromé/verchromt/cromato G-Ø 160 mm, l-184 mm	 Jany, chromé/verchromt/cromato G-Ø 128 mm, l-141 mm	 LB, chromé/verchromt/cromato LM, mat/matt/opaco G-Ø 128 mm, l-132 mm	 Eddy, chromé/verchromt/cromato, gauche/links/sinistra, droite/rechts/destra G-Ø 32 mm, l-75 mm
 Line, chromé/verchromt/cromato G-Ø 160 mm, l-200 mm	 Lux, chromé/verchromt/cromato G-Ø 16 mm, l-34,6 mm	 Nova, chromé mat/verchromt matt / cromato opaco G-Ø 64 mm, l-133 mm	 Paola, chromé/verchromt/cromato G-Ø 96 mm, l-145 mm	 Perfo, chromé/verchromt/cromato G-Ø 160 mm, l-168 mm
 Pure, chromé/verchromt/cromato G-Ø 128 mm, l-138 mm	 Smart, chromé/verchromt/cromato G-Ø 32 mm, l-60 mm	 Soft, chromé/verchromt/cromato G-Ø 128 mm, l-178 mm	 Zebra, chromé/verchromt/cromato G-Ø 192 mm, l-200 mm	

Special Edition: Poignées | Griffe | Maniglie

 Stripes (carré/eckig /angolare), chromé/verchromt/cromato G-Ø 64 mm, l-82 mm	 Stripes, chromé/verchromt/cromato G-Ø 128 mm, l-150 mm	 Stripes, chromé/verchromt/cromato G-Ø 64 mm, l-83 mm
 Stone, chromé/verchromt/cromato G-Ø 64 mm, l-98 mm	 Stripes, chromé/verchromt/cromato G-Ø 160 mm, l-179 mm	 Star, chromé/verchromt/cromato G-Ø 16 mm, l-50 mm
 Stripes (rectangle/rechteckig/ango- lare), chromé/verchromt/cromato G-Ø 128 mm, l-148 mm	 Star, chromé/verchromt/cromato G-Ø 32 mm, l-68 mm	



Liste décor disponible dans toutes les couleurs Framo
Griffleiste in allen Framo-Farben erhältlich
Listello decorativo disponibile in tutti i colori Framo

Special Sizes: Poignées | Griffe | Maniglie

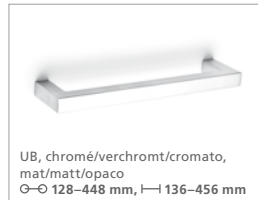
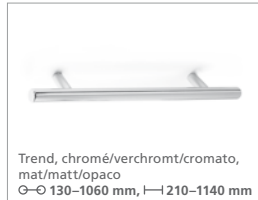
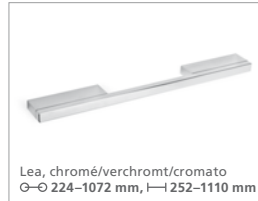
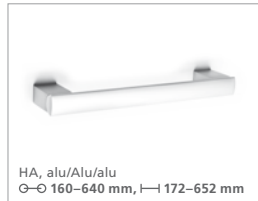
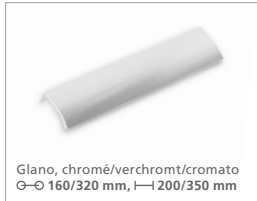
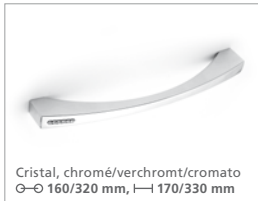

CRISTAL BY FRAMO
 MADE WITH SWAROVSKI® ELEMENTS



FR



DE

WATCH THE CRISTAL MOVIE

WATCH THE CRISTAL MOVIE

Choix | Auswahl | Scelta

Accessoires | Zubehör | Accessori



> 64-1



> 64-2



> 64-3



64-4



> 64-5

Porte-linges | Handtuchhalter | Porta asciugamano



Linear
H—30/38 cm



Fin
H—26/30/40 cm



Pure
H—29/39 cm



Galaxy
H—38 cm



Dasy
H—38 cm



Twin
H—40 cm

framo

Switzerland

Naturel et respectueux de l'environnement.
Natürlich und umweltbewusst.
Naturali ed ecologici.



Environnement et production suisse moderne

Framo s'engage à utiliser des matériaux qui ont été produits écologiquement. Le bois utilisé est produit selon les normes FSC et nous employons du bois suisse très régulièrement. Grâce à différentes améliorations de notre production dans le but de réduire notre consommation électrique, nous constatons une baisse régulière de nos besoins en énergie. Nous consommons exclusivement du courant vert. Nous utilisons nos propres déchets de bois pour le chauffage de notre entreprise.

Umwelt und moderne Schweizer Produktion

Framo engagiert sich dafür, Materialien einzusetzen, die umweltschonend produziert worden sind. Beispielsweise wird das eingesetzte Holz im Normalfall nach FSC-Richtlinien produziert und es handelt sich vielfach sogar um Schweizer Holz. Die Produktion wird konsequent optimiert, um den Stromverbrauch laufend zu senken. Framo verwendet zudem ausschließlich Ökostrom. Die Heizwärme für die Framo-Gebäude wird mit den eigenen Holzabfällen produziert.

Coscienza ambientale e produzione moderna svizzera

Framo è impegnata d'utilizzare prodotti ecologici. Il legno utilizzato è normalmente sotto le norme FSC e legno svizzero. La produzione viene costantemente ottimizzata per ridurre la consumo di energia elettrica. Noi utilizziamo esclusivamente elettricità ecologica. Per il riscaldamento del nostro edificio usiamo i nostri rifiuti di legno.

Nous consomons
du courant vert



produit par Groupe E

Wir beziehen
Ökostrom



produziert durch Groupe E

Lavabos | Becken | Lavabi

Lavabo Framo à poser | Framo-Aufsatzbecken | Lavabo Framo d'appoggio

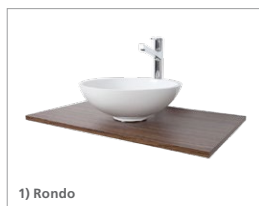

1) Marbre artificiel, sans trop-plein.
Mineralguss ohne Überlauf.
Mineralmarmo senza troppopieno.

2) Céramique, avec trop-plein et plage de robinetterie.
Keramik mit Überlauf und Armaturenbank.
Ceramica, con troppopieno e ripiano per rubinetteria.

3) Céramique, sans trop-plein.
Keramik ohne Überlauf.
Ceramica, senza troppopieno.

4) Céramique, avec trop-plein.
Keramik mit Überlauf.
Ceramica, con troppopieno.

5) Marbre artificiel, avec trop-plein.
Mineralguss mit Überlauf.
Mineralmarmo, con troppopieno.

6) Marbre artificiel + Solid surface
Mineralguss + Solid surface
Mineralmarmo + Solid surface



Il va de soi que nous pouvons également monter le lavabo de votre choix.
Selbstverständlich bauen wir auch Ihr Wunschbecken ein.
Ovviamente saremo lieti di montare anche il lavabo dei vostri sogni.



1



En un moulage

Table et lavabo en verre moulé forment une unité.

Alles aus einem Guss

Abdeckung und Becken aus Glas bilden eine Einheit.

Tutto in un unico blocco

Copertura e lavabo in vetro formano un'unità.

2



En un moulage

Table et lavabo en marbre artificiel ou en céramique forment une unité.

Alles aus einem Guss

Abdeckung und Becken aus Mineralguss oder Keramik bilden eine Einheit.

Tutto in un unico blocco

Copertura e lavabo in quarzo sintetico o ceramica formano un'unità.

3



A fleur

Lavabo en céramique inséré dans une table sans joint apparent (stratifié et Compact).

Fugenlos kombiniert

Keramikbecken fugenlos mit Abdeckung vereint (Kunstharz und Compact).

Abbinato senza giunti

Lavabo in ceramica unito alla copertura senza giunti (resina sintetica e Compact).

4



Sans joint apparent

Lavabo en céramique montage par-dessous (mineral-art, verre, granit ou Starlight).

Schön kombiniert

Keramikbecken fugenlos mit Abdeckung vereint (Mineral-art, Glas, Granit oder Starlight).

Ben combinato

Lavabo in ceramica unito alla copertura senza giunti (mineral-art, vetro, quarzo minerale o Starlight)

5



Posé

Lavabo en céramique sur table dans le matériau de votre choix.

Aufgesetzt kombiniert

Becken aufgesetzt auf die Abdeckung nach Wahl.

Abbinamento d'appoggio

Lavabo appoggiato alla copertura scelta.

6



Semi-encastré

Lavabo semi-encastré par le dessus. Une partie du lavabo reste visible au-dessus de la table.

Halbeinbau

Becken von oben halb eingesetzt. Ein Teil des Beckens ist oberhalb der Abdeckung sichtbar.

Semi-incasso

Lavabo installato a semi-incasso dall'alto. Una parte del lavabo è visibile al di sopra della copertura.

Couleurs | Farben | Colori

Stratifié brillant • Stratifié bois & structure
Stratifié moderne mat • Laqué • RAL

En complément de notre très large palette de couleurs en stratifié, vous pouvez aussi commander chaque programme Framo en version laquée. Dans ce cas, vous disposez de deux finitions possibles, soit en mat ou en brillant. Chacune de ces deux catégories comprend six couleurs. Naturellement, vous pouvez aussi choisir n'importe quelle couleur RAL.

Un grand choix de couleurs et matériaux qui vous offrent des variétés de combinaisons presque infinies. Notre leitmotiv «made for me» est une invitation à laisser libre cours à votre fantaisie.

Kunstharz Hochglanz • Kunstharz Holz & Struktur
Kunstharz Modern matt • Lackierte Farben • RAL

Zusätzlich zu unserer sehr breiten Palette an Kunstharzfarben können Sie auch jedes unserer Framo-Möbel lackiert bestellen. Hierbei stehen sechs Farben in Schleiflack matt und sechs Farben in Hochglanz zur Verfügung. Selbstverständlich können Sie auch jede beliebige RAL-Farbe bestellen. Auch Echtholzfronten sind lieferbar.

Die grosse Auswahl an Farben und Materialien ermöglicht Ihnen eine nahezu unendliche Kombinationsvielfalt. Getreu unserem Leitmotiv «made for me» fordern wir Sie auf, Ihrer Fantasie freien Lauf zu lassen.

Resina sintetica, elevata brillantezza
• Resina sintetica legno e struttura • Resina sintetica moderna opaca
Colori laccati • RAL

Oltre al nostro vastissimo assortimento di colori in resina sintetica tutti i mobili Framo possono essere ordinati in versione verniciata. In questo caso sono disponibili sei colori in vernice carteggiabile opaca e sei colori ultra-brillanti. Naturalmente possono essere ordinati tutti i colori RAL.

La vasta scelta di colori e materiali consente una varietà di combinazioni quasi infinita. Fedeli al nostro motto «made for me» vi invitiamo a liberare la fantasia.



Visualisation de couleurs en 3D – Framo.ch

Visualisez directement le meuble de salles de bains avec la couleur Framo de votre choix.

3D-Visualisierung Framo.ch

Ihre Wunschfarbe von Framo visualisiert direkt auf dem Badmöbel. Abrufbar auf unserer Website.

Visualizzazione dei colori 3D – Framo.ch

Visualizzate direttamente il mobile da sala da bagno con il colore Framo di vostra scelta.

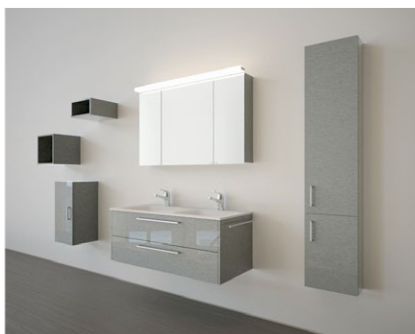

Conseil d'entretien Pflegeratgeber Consigli di manutenzione

De cette manière, vos meubles conservent pleinement leur éclat. Vous trouverez sur notre site internet une fiche d'entretien à télécharger.

Damit Ihre Möbel stets in vollem Glanz erstrahlen, können Sie auf unserer Internetseite unseren Pflegeratgeber herunterladen.

In modo che i vostri mobili appaiono lucidi, voi potete scaricare il manuale «manutenzione mobili» sul nostro sito internet.

Conseil d'entretien Pflegeratgeber



framo
Switzerland





> 70-1

Solution buanderie Waschraumlösung Soluzione lavanderia

Vous cherchez à optimiser, et ce de manière fonctionnelle et belle, votre espace buanderie en y intégrant votre machine à laver, votre sèche-linge, votre évier ou autres selon vos propres désirs? Framo vous offre une solution moderne pour aménager votre buanderie.

Suchen Sie eine flexible, funktionale und schöne Lösung, um Ihren Waschküchenarbeitsplatz mit Waschmaschine, Wäschetrockner und Handwaschbecken optimal nach Ihren Wünschen einzurichten? Framo bietet Ihnen hierfür eine moderne Waschraumlösung an.

Cercate una soluzione flessibile, funzionale e bella per allestire in modo ottimale per le vostre esigenze la lavanderia con lavatrice, asciugatrice e lavabo? Con la proposta Framo specifica per questo ambiente vi offriamo una soluzione moderna.



Exemples | Beispiele | Esempi

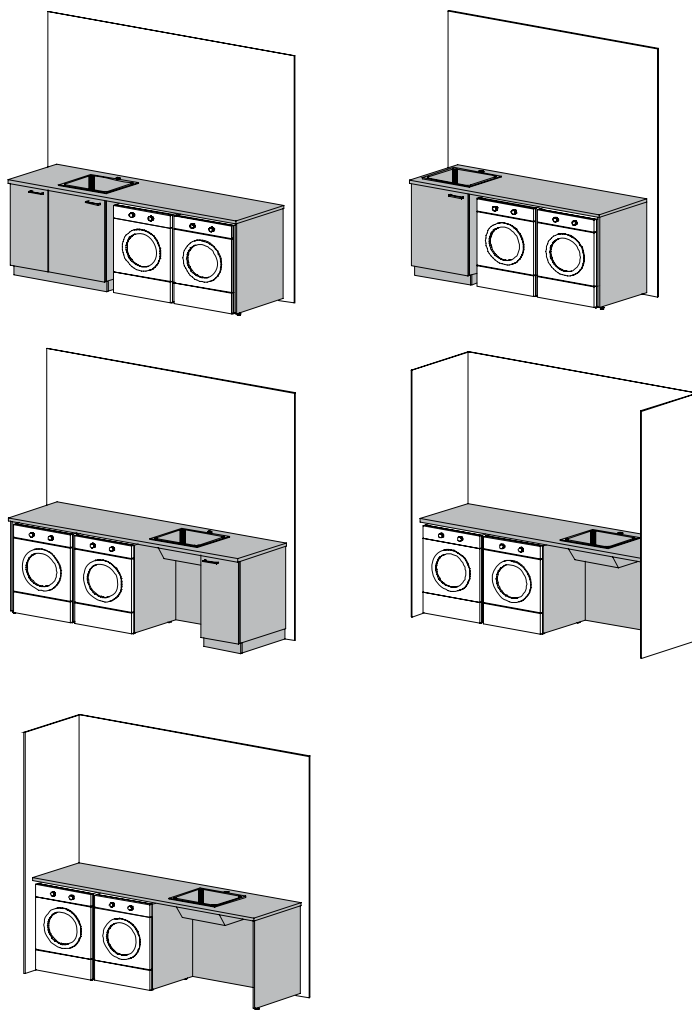

Mesures | Masse | Misure

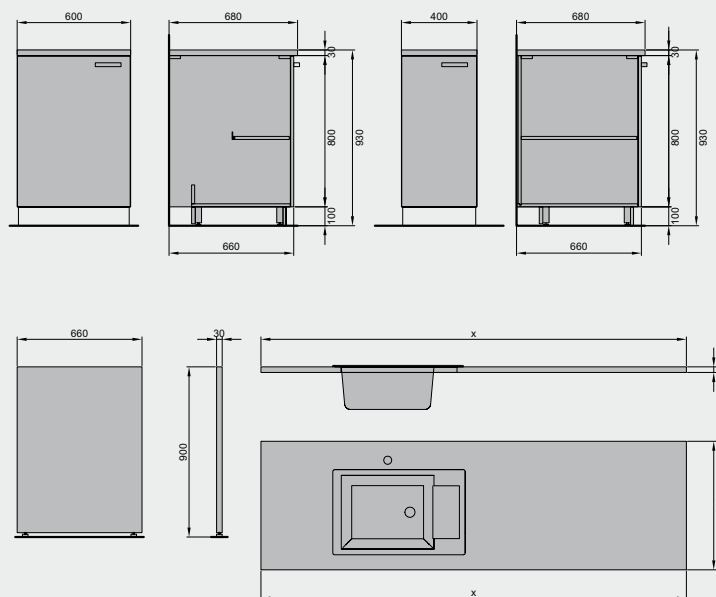

FR



DE

Derrière les coulisses Hinter den Kulissen Dietro le quinte



1.
Esquisses
Skizzen
Schizzo

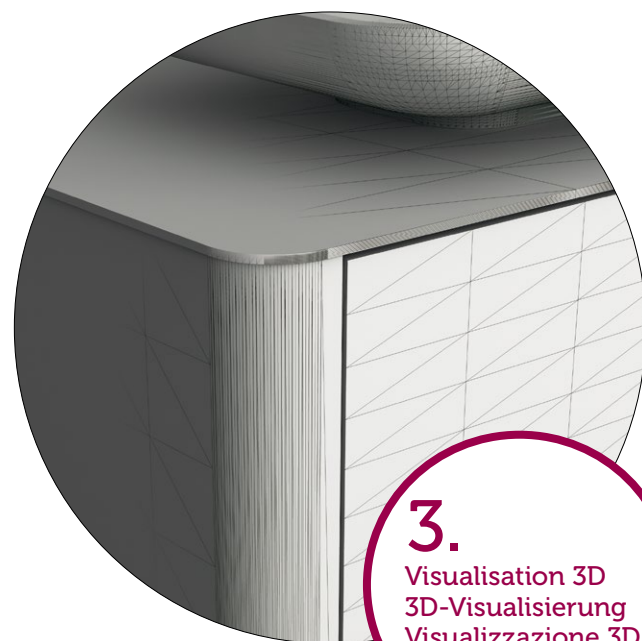

3.
Visualisation 3D
3D-Visualisierung
Visualizzazione 3D

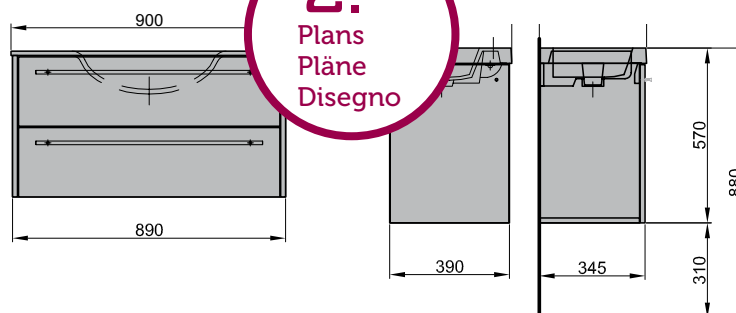

2.
Plans
Pläne
Disegno



5.
Production
Produktion
Produzione



6.
Produit fini
Fertiges Produkt
Prodotto finito

4.
Impression 3D
3D-Druck
Stampa 3D



Soucieux de la satisfaction de ses clients, l'équipe Framo utilise ses compétences ainsi que des outils de pointe pour pouvoir leur fournir en permanence de nouveaux produits accompagnés d'un service rapide et de qualité.

Das Framo-Team setzt alle seine Fähigkeiten sowie modernste Hilfsmittel ein, um seinen Kunden laufend schöne, neue Produkte und modernste Dienstleistungen zur Verfügung zu stellen.

Il team Framo impegna tutte le sue conoscenze e gli strumenti più moderni per offrire ai propri clienti splendidi articoli sempre nuovi e servizi all'avanguardia.

Service Service Servizio

framo

Switzerland



- 1 N° de confirmation de comande
Auftragsnummer
Numero d'ordine
- 2 Délai de fabrication
Fertigungswoche
Settimana di fabbricazione
- 3 N° personnel du contrôle de qualité
Personalisierte Kontrollnummer und Qualitätskontrolle
Numero di controllo personalizzato e controllo qualità

Qualité et service clients

Il nous tient à cœur que vous profitiez durant de nombreuses années de vos meubles de salles de bains Framo. Chacun de nos produits est livré avec un numéro d'ordre clair. Ainsi, nous pouvons encore identifier de façon précise après des années quel produit est concerné par votre demande de service après-vente. Ce numéro nous permet de régler rapidement une demande de pièces de rechange ou toute intervention. Framo tient à ses meubles.

Qualität und Kundendienst

Auch nach Jahren setzen wir uns dafür ein, dass Sie noch Freude an Ihrem Framo-Badmöbel haben. Jedes unserer Produkte wird mit einer eindeutigen Auftragsnummer versehen. So können wir noch nach Jahren bei einem Servicefall genau identifizieren, um welches Framo-Produkt es sich handelt, und rasch mit unserem Kundendienst mit den notwendigen Ersatzteilen intervenieren. Framo steht zu seinen Produkten.

Qualità e servizio clienti

Ciascuno dei nostri prodotti viene dotato di un numero d'ordine univoco; in tal modo siamo in grado di identificare esattamente il prodotto Framo anche dopo anni, intervenendo rapidamente con i pezzi di ricambio necessari. Framo ha a cuore i suoi prodotti.

Nous sommes là pour vous | Gerne für Sie da | Siamo qui per voi

Notre équipe de vente interne est à votre entière disposition. N'hésitez pas à contacter nos collaborateurs pour toute demande de renseignements techniques, de prix ou d'offres.

Für Preisankünfte und Offertanfragen bitten wir Sie direkt um Kontaktnahme mit unseren Mitarbeiter und Mitarbeiterinnen.

Il nostro team di vendita interno è a vostra disposizione. Non esitate a contattare il nostro staff per qualsiasi richiesta di informazioni tecniche, prezzi o di offerta.

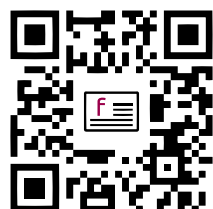

Framo SA, La Maillarde, 1680 Romont
Tél. 026 651 96 51, Fax 026 651 96 50
www.framo.ch, info@framo.ch



Fait pour moi.

TOUTES LES INFORMATIONS NÉCESSAIRES POUR VOUS AIDER DANS VOTRE CHOIX: WWW.FRAMO.CH
FACILE, SIMPLE ET RAPIDE.



Für mich gemacht.

ALLE INFORMATIONEN, WELCHE SIE BENÖTIGEN, UM SICH ZU ENTSCHEIDEN: WWW.FRAMO.CH
EINFACH, ÜBERSICHTLICH UND ANSCHAULICH.

Fatto apposta per me.

TUTTE LE INFORMAZIONI CHE VI SERVONO PER DECIDERE SI TROVANO AL SITO WWW.FRAMO.CH
SEMPLICE, PANORAMICO E CHIARO.



www.framo.ch

Unsere Ausstellungen | Nos expositions | Le nostre esposizioni

- Wir freuen uns, Sie in unseren Ausstellungen begrüßen und beraten zu dürfen.
- Nous nous réjouissons de vous accueillir et de vous conseiller dans l'une de nos expositions.
- Siamo lieti di accogliervi e consigliarvi in una delle nostre esposizioni.

Deutschschweiz: Baubedarf - Richner - Miauton

- Industrie Neubuchs
5001 Aarau
Tel. 062 834 37 37
- Gellertstrasse 212
4052 Basel
Tel. 061 560 74 74
- Morgenstrasse 136
3018 Bern
Tel. 031 336 60 60
- Pulverweg 9
3400 Burgdorf
Tel. 034 420 74 00
- Kalchbühlstrasse 40
7000 Chur
Tel. 081 258 44 44
- Mööslmatten 8
6218 Ettiswil
Tel. 041 984 01 90
- Hauptstrasse 14 A
5502 Hunzenschwil
Tel. 062 889 45 00

- Eichwiesstrasse 2
8645 Jona
Tel. 055 221 11 11
- Industriestrasse 11
Postfach
3210 Kerzers
Tel. 031 336 60 60
- Arsenalstrasse 21
6010 Kriens
Tel. 041 317 03 03
- Erlenstrasse 1
6343 Rotkreuz
Tel. 041 798 05 80
- Rheinweg 1
8200 Schaffhausen
Tel. 052 624 78 95
- Muttenstrasse 13
4500 Solothurn
Tel. 032 625 61 11

- Bogenstrasse 14
9001 St. Gallen
Tel. 071 274 52 52
- Industriestrasse 18
8604 Volketswil
Tel. 043 399 43 43
- Technoramastrasse 15
8404 Winterthur
Tel. 052 244 01 44
- Würzgrabenstrasse 6
8048 Zürich
Tel. 044 438 25 25

Suisse Romande: Rapin - Glasson - Gétaz - Miauton

- Z.I. Les Orions
1860 Aigle
Tél. 024 468 61 00
- Rte de Fribourg 1
1630 Bulle
Tél. 026 913 66 33
- Z.I. Nord
Ch. Bas-de-Plan 1
1030 Bussigny
Tél. 021 702 04 15
- Av. de la Praille 45
1227 Carouge
Tél. 022 918 15 00
- Le Pré, Les Moulins
1660 Château-d'Oex
Tél. 026 924 24 24
- Rte des Peupliers 17
1964 Conthey
Tél. 027 345 36 37
- Ch. des Malpieres 1
2088 Cressier
Tél. 032 755 96 96
- Littoral Parc
Rte de la Tuilière 10
1163 Etoy
Tél. 021 821 23 00
- Rte André Pillier 1
1762 Givisiez
Tél. 026 467 81 11

- Rte de Champ-Colin 15
1260 Nyon
Tél. 022 994 90 00
- Z.I. En Grivaz
Rte de Granges 14
1607 Palézieux
Tél. 021 907 92 43
- Rte de la Grosse-Pierre 16
1530 Payerne
Tél. 026 662 50 00
- Rte de Raboud 2
1680 Romont
Tél. 026 651 96 00
- Rue du Manège 10
3960 Sierre
Tél. 027 452 35 35
- Rue de la Dixence 33
1950 Sion
Tél. 027 345 36 90
- Z.I. la Veyre
1806 St-Légier
Tél. 021 923 37 00
- Z.I. A, Rte du Pré du Bruit 4
1844 Villeneuve
Tél. 021 967 10 00
- Lonzastrasse 2
3930 Visp
Tél. 027 948 85 00
- Rue des Uttns 29
1400 Yverdon-les-Bains
Tél. 024 424 86 00

Ticino: Regusci Reco

- Via San Gottardo 18A
6532 Arbedo-Castione
Tel. 091 820 24 00

- Via Cantonale 34a
6928 Manno
Tel. 091 605 24 34

Legende | Légende | Legenda

- Aussengestaltung
Aménagements extérieurs
Sistemazione esterna
- Bäder | Salles de bains | Bagni
- Haushaltgeräte | Appareils électroménagers
Apparecchi elettrodomestici
- Küchen | Cuisines | Cucine
- Parkett | Parquets | Parquet
- Türen | Portes | Porte - Suisse romande & Ticino
- Platten | Carrelages | Piastrelle



Besuchen Sie uns auf unseren Internetseiten für weitere Auskünfte.

Visitez nos sites internet pour de plus amples informations.

Visitate il nostro sito internet per maggiori informazioni.